

# LÁMPARAS COLGANTES Y PLAFONES

HANGING & CEILING LAMPS

SUSPENSIONS ET PLAFONNIERS



ARLÉS 4



CRETA 8



LAIA 12



KITO 14



ACAPULCO OUTDOOR 16



ACAPULCO INDOOR 20



INDIANA XL 26



INDIANA 28



TOSCANA 30

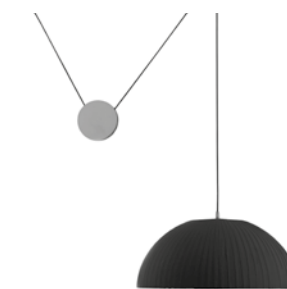

SIOUX 34



KEA 36



MILOS 40



MANHATTAN 46



THIRA 48



AIR 50



BOSTON 52



MOON 54



MOON 56



RONDO 58



CUADRO 60



TREBOL 62



PARIS 64



UFO 66



ARCO 70



OSLO 72



MADISON 74



ASTORIA 78



AURA 84



GABIA 88



CAPUCHINA 90



SOHO 92



HARLEM 96



BRONX 100



LONDON 102



PROA 104



BROOKLIN 106



CHELSEA 108

# ARLÉS C

BY MARIANO CHITARRINI



max. 40 W | E27

- 1 x E-27 vintage LED 8W
- 1 x E-27 vintage Edison 40W

## FLORÓN EN ÓXIDO

OXIDE CEILING ROSE  
PAVILLON EN OXYDE

## PANTALLA DE MDF

MDF LAMPSHADE  
ABAT-JOUR DE MDF

Pantalla medium 25 x 39 x 25 cm. Pantalla XL 55 x 36 x 55 cm. Se puede incluir un difusor de luz textil

Medium size lampshade 25 x 39 x 25 cm. XL lampshade 55 x 36 x 55 cm. It is possible to include a textile diffuser of light

Abat-jour medium 25 x 39 x 25 cm. Abat-jour XL 55 x 36 x 55 cm. Il est possible d'inclure un diffuseur textile de lumière

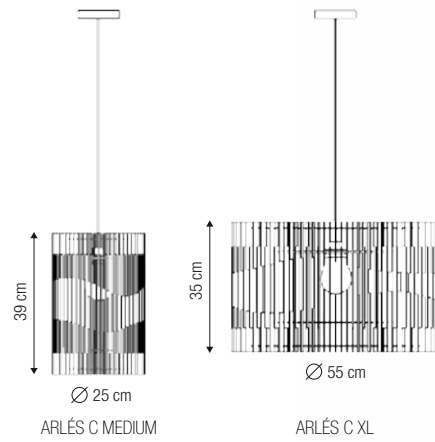

p. 274



p. 112



p. 212

Con pantalla difusora ^  
With diffuser lampshade  
Avec abat-jour diffuseur

Sin pantalla difusora >  
Without diffuser lampshade  
Sans abat-jour diffuseur

ARLÉS C MEDIUM	ARLÉS C XL	FLORÓN CEILING ROSE AVILLON	PANTALLA LAMPSHADE ABAT-JOUR	CABLE CABLE CÂBLE
1026	1028	● Óxido Oxide Oxyde	Tablero de fibra (MDF) Medium-density fibreboard (MDF) Panneau de fibres à densité moyenne (MDF)	Algodón marrón Brown cotton Coton marron
1027	1029	● Óxido Oxide Oxyde	Tablero de fibra (MDF) con pantalla difusora Medium-density fibreboard (MDF) with diffuser lampshade Panneau de fibres à densité moyenne (MDF) avec abat-jour diffuseur	Algodón marrón Brown cotton Coton marron





# CRETA

BY XAVIER SOLÉ

IP20 CE

max. 6 W | GU10

A+ 1 x GU10 LED

ESTRUCTURA EN CROMO

CHROME STRUCTURE

STRUCTURE EN CHROME

PANTALLA DE MADERA

WOOD LAMPSHADE

ABAT-JOUR EN BOIS

Cuerpo ovalado diámetro 11 cm

Oval body diameter 11 cm

Corps oval diamètre 11 cm

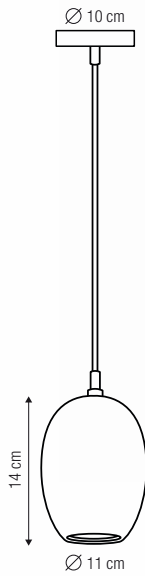

	FLORÓN CEILING ROSE PAVILLON	PANTALLA LAMPSHADE ABAT-JOUR	CABLE CABLE CÂBLE
1030	Cromo Chrome Chrome	Madera de roble Oak wood Bois de chêne	Algodón negro Black cotton Coton noir
1031	Cromo Chrome Chrome	Madera lacada en blanco White lacquered wood Bois laqué en blanc	Algodón blanco White cotton Coton blanc



# LAIA C

BY XJER STUDIO



max. 42 W | E27

**A+** PCB 155 LEDS 40W - 220V

3.250 Lumens

3.000 K

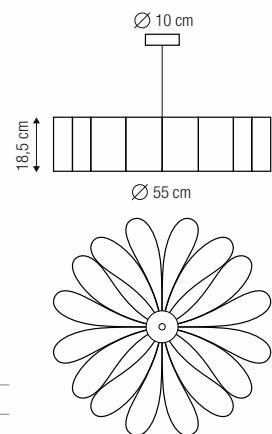

ESTRUCTURA EN BLANCO

WHITE STRUCTURE

STRUCTURE EN BLANC

PANTALLA DE MADERA DE HAYA O PVC BLANCO

BEECH WOOD OR WHITE PVC LAMPSHADE

ABAT-JOUR EN BOIS D'HÊTRE OU EN PVC BLANC

Cable de suspensión ajustable de acero con

autobloqueo. Pantalla diámetro 55 cm

Adjustable self-locking steel suspension cable.

Lampshade diameter 55 cm

Câble de suspension réglable en acier à verrouillage

automatique. Abat-jour diamètre 55 cm

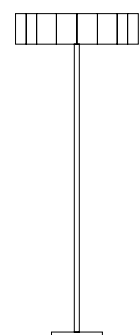

p. 276

	ESTRUCTURA STRUCTURE STRUCTURE	PANTALLA LAMP SHADE ABAT-JOUR	CABLE CABLE CÂBLE
1032	● Blanco White   Blanc	■ Madera de haya Beech wood   Bois d'hêtre	● Algodón blanco White cotton   Coton blanc
1033	● Blanco White   Blanc	■ PVC blanco White PVC   PVC blanc	● Algodón blanco White cotton   Coton blanc



# KITO C

BY XAVIER SOLÉ



KITO 80 CM

**A+** Tira LED 13W - 12V  
1.000 Lumens  
3.000 K

KITO 120 CM

**A+** Tira LED 20W - 12V  
1.500 Lumens  
3.000 K



## FLORÓN EN NÍQUEL

NICKEL CEILING ROSE

PAVILLON EN NICKEL

## PANTALLA DE MADERA DE ROBLE

OAK WOOD LAMPSHADE

ABAT-JOUR EN BOIS DE CHÊNE

Cables de suspensión ajustables de acero con autobloqueo. Disponible en 80 o 120 cm

Adjustable self-locking steel suspension cables.

Available in 80 or 120 cm

Câbles de suspension réglables en acier à verrouillage automatique. Disponible en 80 ou 120 cm

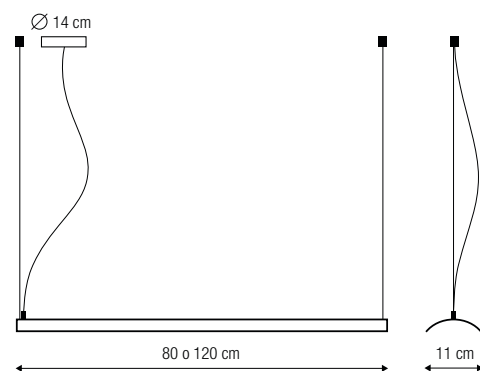

p. 114



p. 114

	FLORÓN CEILING ROSE PAVILLON	PANTALLA LAMPSHADE ABAT-JOUR	LONGITUD LENGTH LONGUEUR	CABLE CABLE CÂBLE
1034	Níquel Nickel   Nickel	Madera de roble Oak wood   Bois de chêne	80 cm	Transparente Transparent   Transparent
1035	Níquel Nickel   Nickel	Madera de roble Oak wood   Bois de chêne	120 cm White cotton   Coton blanc	Transparente Transparent   Transparent



# ACAPULCO outdoor c

BY XJER STUDIO



3.000 k - 290 lumens

FLORÓN EN BLANCO O NEGRO

WHITE OR BLACK CEILING ROSE

PAVILLON EN BLANC OU EN NOIR

PANTALLA DE CUERDA DE POLIAMIDA

STRING LAMPSHADE MADE OF POLYAMIDE

ABAT-JOUR DE CORDE DE POLYAMIDE

Sin conexión a red. Alimentación con fuente de luz led con batería recargable por sistema de inducción. 6h duración máxima potencia. Sujeción magnética a la pantalla

No connection to the network. Led light source power supply with rechargeable battery by induction system. 6h of battery life. Magnetic grip to the lampshade

Sans connexion au réseau. Source d'alimentation LED avec batterie rechargeable par système d'induction. 6h d'autonomie de batterie. Fixation magnétique à l'abat-jour

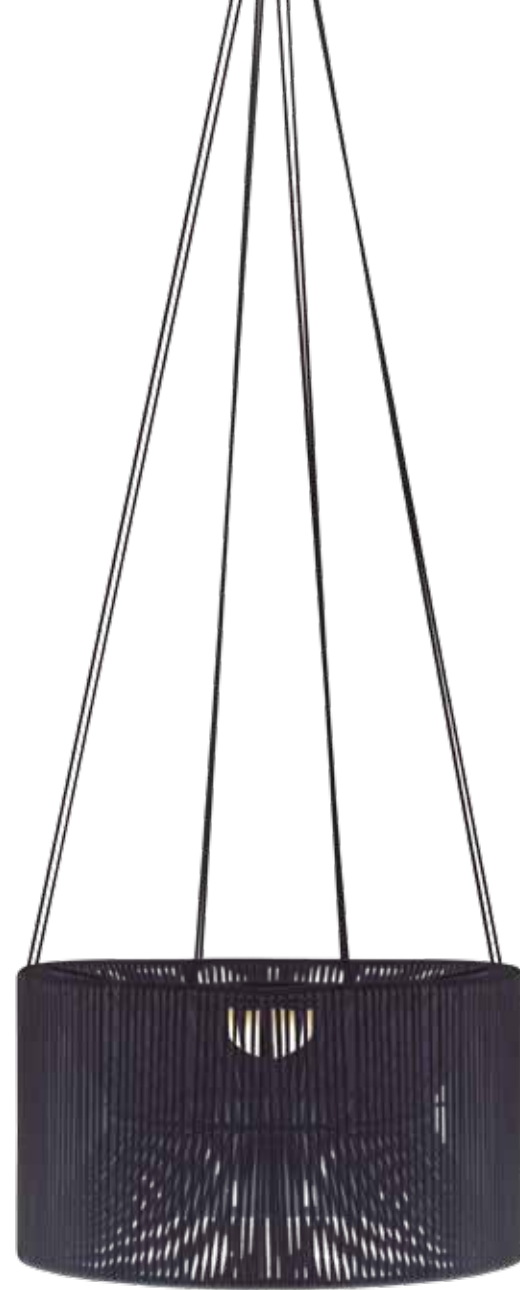
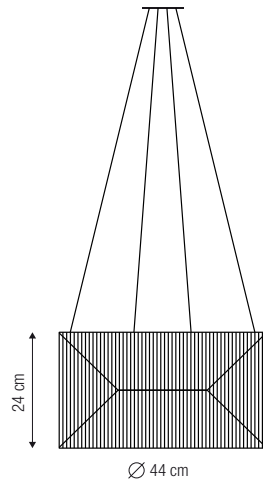

Batería recargable por inducción con micro USB  
Rechargeable induction battery with micro USB  
Batterie à induction rechargeable avec micro USB

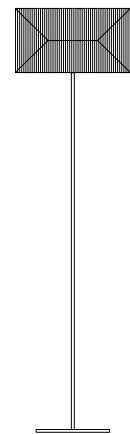

p. 268

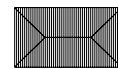

p. 206

PANTALLA  
LAMP SHADE  
ABAT-JOUR

1015 Encordada blanco roto  
Off-white stringed  
Cordé en blanc cassé

1016 Encordada negra  
Black stringed  
Cordé en noir







# ACAPULCO indoor C

BY XJER STUDIO



max. 42 W | E27

- A+** 1 x E-27 LED 12W
- A** 1 x E-27 FLC 25W
- B** 1 x E-27 A60 ECO 42W

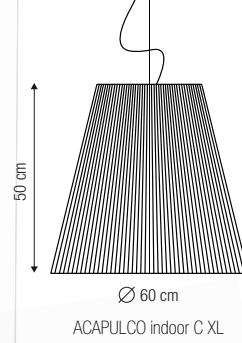
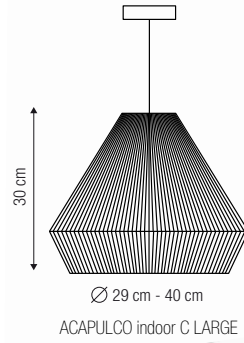
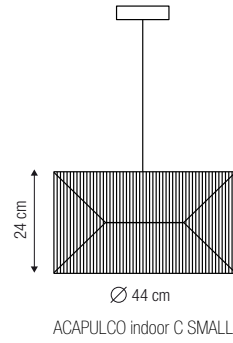

FLORÓN EN BLANCO, NEGRO O NÍQUEL

WHITE, BLACK OR NICKEL CEILING ROSE

PAVILLON EN BLANC, EN NOIR OU EN NICKEL

PANTALLA DE CUERDA DE POLIAMIDA O DE CUERDA DE ALGODÓN

STRING LAMP SHADE MADE OF POLYAMIDE OR COTTON

ABAT-JOUR DE CORDE DE POLYAMIDE OU DE CORDE DE COTON

Colgante XL con cable de suspensión ajustable de acero con autobloqueo

XL hanging lamp with adjustable self-locking steel suspension cable

Suspension XL avec câble de suspension réglable en acier à verrouillage automatique

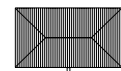

p. 272

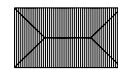

p. 210

SMALL

LARGE

XL

FLORÓN  
CEILING ROSE  
PAVILLON

PANTALLA  
LAMP SHADE  
ABAT-JOUR

CABLE  
CABLE  
CÂBLE

1017		Blanco White Blanc	Cuerda poliamida blanco roto Off-white polyamide string Corde en polyamide blanc cassé	Algodón negro Black cotton Coton noir	
1018		Negro Black Noir	Cuerda poliamida negra Black polyamide string Corde en polyamide noir	Algodón negro Black cotton Coton noir	
	1019	Blanco White Blanc	Cuerda algodón verde* Green cotton string Corde en coton vert	Algodón blanco White cotton Coton blanc	
	1020	Negro Black Noir	Cuerda algodón beige* Beige cotton string Corde en coton beige	Algodón negro Black cotton Coton noir	
		1021	Níquel Nickel Nickel	Cuerda poliamida blanco roto Off-white polyamide string Corde en polyamide blanc cassé	Transparente Transparent Transparent
		1022	Níquel Nickel Nickel	Cuerda poliamida negra Black polyamide string Corde en polyamide noir	Transparente Transparent Transparent

\* 80% algodón reciclado y 20% otras fibras | 80% recycled cotton and 20% other fibers | 80% coton recyclé et 20% autres fibres





# INDIANA XL

BY JORDI LLOPIS



max. 42 W | E27

- A+** 2 x E-27 LED 12W
- A** 2 x E-27 FLC 25W
- B** 2 x E-27 A60 ECO 42W

PANTALLA DOBLE ENCINTADA DE ORGANZA EN BLANCO, GRIS, BEIGE O NEGRO

DOUBLE RIBBONED LAMP SHADE IN WHITE, GREY, BEIGE OR BLACK ORGANZA

ABAT-JOUR DOUBLE ENRUBANNÉ EN ORGANZA BLANC, GRIS, BEIGE OU NOIR

Cable de suspensión ajustable de acero con autobloqueo. Pantalla exterior diámetro 40 cm

Adjustable self-locking steel suspension cable. Outside lampshade diameter 40 cm

Câble de suspension réglable en acier à verrouillage automatique. Abat-jour extérieur diamètre 40 cm

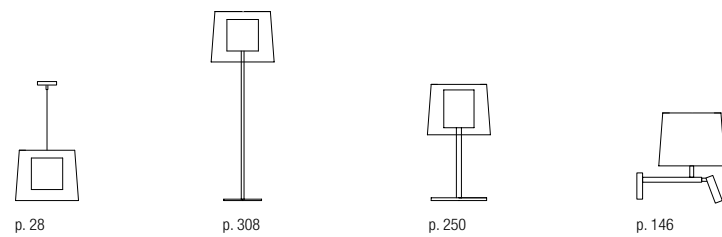

	PANTALLA LAMP SHADE ABAT-JOUR	CABLE CABLE CÂBLE
1036	Organza blanca White organza   Organza blanc	PVC negro Black PVC   PVC noir
1037	Organza gris Grey organza   Organza gris	PVC negro Black PVC   PVC noir
1038	Organza beige Beige organza   Organza beige	PVC negro Black PVC   PVC noir
1039	Organza negra Black organza   Organza noir	PVC negro Black PVC   PVC noir



# INDIANA C

BY JORDI LLOPIS



max. 42 W | E27



**A+** 1 x E-27 LED 12W

**A** 1 x E-27 FLC 25W

**B** 1 x E-27 A60 ECO 42W

FLORÓN EN NEGRO

BLACK CEILING ROSE

PAVILLON EN NOIR

PANTALLA DOBLE ENCINTADA DE ORGANZA EN BLANCO, GRIS, BEIGE O NEGRO

DOUBLE RIBBONED LAMP SHADE IN WHITE, GREY, BEIGE OR BLACK ORGANZA

ABAT-JOUR DOUBLE ENRUBANNÉ EN ORGANZA BLANC, GRIS, BEIGE OU NOIR

Cable de suspensión ajustable de acero con autobloqueo. Pantalla exterior diámetro 50 cm

Adjustable self-locking steel suspension cable. Outside lampshade diameter 50 cm

Câble de suspension réglable en acier à verrouillage automatique. Abat-jour extérieur diamètre 50 cm

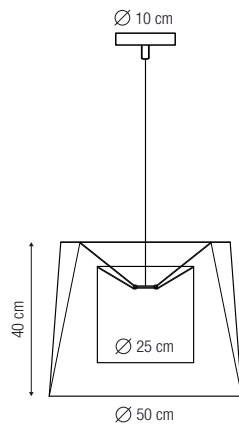

p. 26



p. 308

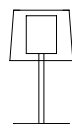

p. 250



p. 146

FLORÓN  
CEILING ROSE  
PAVILLON

PANTALLA  
LAMP SHADE  
ABAT-JOUR

CABLE  
CABLE  
CÂBLE

1040	● Negro Black   Noir	■ Organza blanca White organza   Organza blanc	● Algodón negro Black cotton   Coton noir
1041	● Negro Black   Noir	■ Organza gris Grey organza   Organza gris	● Algodón negro Black cotton   Coton noir
1042	● Negro Black   Noir	■ Organza beige Beige organza   Organza beige	● Algodón negro Black cotton   Coton noir
1043	● Negro Black   Noir	■ Organza negra Black organza   Organza noir	● Algodón negro Black cotton   Coton noir



# TOSCANA C



max. 42 W | E27

- A+** 2 x E-27 LED 12W
- A** 2 x E-27 FLC 25W
- B** 2 x E-27 A60 ECO 42W

## FLORÓN EN NÍQUEL

NICKEL CEILING ROSE

PAVILLON EN NICKEL

## PANTALLA ENCINTADA EN BLANCO, NEGRO, BEIGE O ROJO

RIBBONED LAMPSHADE IN WHITE, BLACK, BEIGE OR RED

ABAT-JOUR ENRUBANNÉ EN BLANC, NOIR, BEIGE OU ROUGE

Cable de suspensión ajustable de acero con autobloqueo. Pantalla 50 x 30 x 40 cm

Adjustable self-locking steel suspension cable. Lampshade 50 x 30 x 40 cm

Lampshade 50 x 30 x 40 cm

Câble de suspension réglable en acier à verrouillage automatique. Abat-jour 50 x 30 x 40 cm

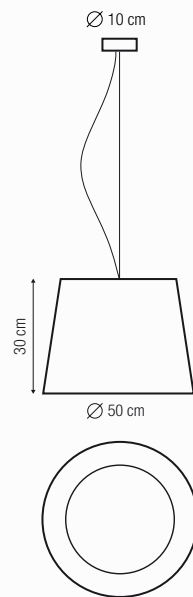

p. 312

	FLORÓN CEILING ROSE PAVILLON	PANTALLA LAMPSHADE ABAT-JOUR	CABLE CABLE CÂBLE
1044	Níquel Nickel   Nickel	Encintada blanca White ribboned   Ruban blanc	Transparente Transparent   Transparent
1045	Níquel Nickel   Nickel	Encintada roja Red ribboned   Ruban rouge	Transparente Transparent   Transparent
1046	Níquel Nickel   Nickel	Encintada beige Beige ribboned   Ruban beige	Transparente Transparent   Transparent
1047	Níquel Nickel   Nickel	Encintada negra Black ribboned   Ruban noir	Transparente Transparent   Transparent





# SIoux



max. 42 W | E27

- A+** 2 x E-27 LED 12W
- A** 2 x E-27 FLC 25W
- B** 2 x E-27 A60 ECO 42W

**ESTRUCTURA EN CROMO**

CHROME STRUCTURE

STRUCTURE EN CHROME

**PANTALLA EN FORMA DE MEDIA ESFERA**

ENCINTADA EN NEGRO, ROJO, BEIGE O BLANCO

HALF SPHERE SHAPE LAMPSHADE RIBBONED

IN BLACK, RED, BEIGE OR WHITE COLOR

ABAT-JOUR EN FORME DE DEMI-SPHÈRE RUBAN

NOIR, ROUGE, BEIGE OU BLANC

Disponible con sistema de disco y polea o con cable de suspensión ajustable de acero con autobloqueo. Pantalla diámetro 40 o 50 cm

Available with up and down system or with adjustable self-locking steel suspension cable.

Lampshade diameter 40 or 50 cm

Disponible avec système de montée et descente ou avec câble de suspension réglable en acier à verrouillage automatique. Abat-jour diamètre 40 ou 50 cm

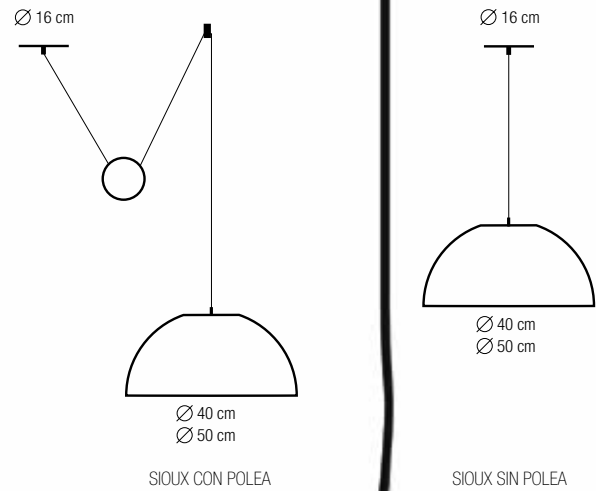

**SIoux CON POLEA**  
SIoux WITH PULLEY  
SIoux AVEC POULIE

40 CM	50 CM	FLORÓN CEILING ROSE PAVILLON	PANTALLA LAMPSHADE ABAT-JOUR	CABLE CABLE CÂBLE
1048	1049	Cromo Chrome   Chrome	Encintada blanca White ribboned   Ruban blanc	Algodón negro Black cotton   Coton noir
1050	1051	Cromo Chrome   Chrome	Encintada roja Red ribboned   Ruban rouge	Algodón negro Black cotton   Coton noir
1052	1053	Cromo Chrome   Chrome	Encintada beige Beige ribboned   Ruban beige	Algodón negro Black cotton   Coton noir
1054	1055	Cromo Chrome   Chrome	Encintada negra Black ribboned   Ruban noir	Algodón negro Black cotton   Coton noir

**SIoux SIN POLEA**  
SIoux WITHOUT PULLEY  
SIoux SANS POULIE

1056	1057	Cromo Chrome   Chrome	Encintada blanca White ribboned   Ruban blanc	Algodón negro Black cotton   Coton noir
1058	1059	Cromo Chrome   Chrome	Encintada roja Red ribboned   Ruban rouge	Algodón negro Black cotton   Coton noir
1060	1061	Cromo Chrome   Chrome	Encintada beige Beige ribboned   Ruban beige	Algodón negro Black cotton   Coton noir
1062	1063	Cromo Chrome   Chrome	Encintada negra Black ribboned   Ruban noir	Algodón negro Black cotton   Coton noir

# KEA C



**A+** GU-10 LED  
GU-10 ECO halogen

FLORÓN Y CUERPO TUBULAR EN GRIS, BLANCO,  
NEGRO O COLOR RAL

GREY, WHITE, BLACK OR RAL COLOR CEILING

LAMP & TUBULAR BODY

PAVILLON ET CORPS TUBULAIRE EN GRIS, EN

BLANC, EN NOIR OU EN COULEUR RAL

Díámetro cuerpo tubular 5,5 cm

Tubular body diameter 5,5 cm

Diamètre corps tubulaire 5,5 cm

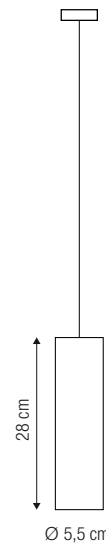

KEA DE SUSPENSIÓN

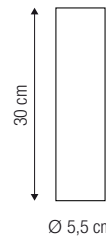

KEA FOCO PLAFÓN

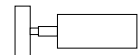

p. 134

KEA DE SUSPENSIÓN HANGING LAMP KEA KEA SUSPENSION	KEA FOCO PLAFÓN CEILING LAMP KEA KEA PLAFONNIER	FLORÓN CEILING ROSE PAVILLON	CUERPO TUBULAR TUBULAR BODY CORPS TUBULAIRE	CABLE CÂBLE
1282		● Negro   Black   Noir	■ Negro   Black   Noir	Algodón negro   Black cotton   Coton noir
1283		● Blanco   White   Blanc	■ Blanco   White   Blanc	Algodón blanco   White cotton   Coton blanc
1284		● Blanco   White   Blanc	■ Blanco   White   Blanc	Algodón negro   Black cotton   Coton noir
1285		● Gris   Grey   Gris	■ Gris   Grey   Gris	Algodón negro   Black cotton   Coton noir
1286		Ⓜ Color RAL RAL color   Couleur RAL	Ⓜ Color RAL RAL color   Couleur RAL	Algodón negro Black cotton   Coton noir
	1287		■ Negro   Black   Noir	
	1288		■ Blanco   White   Blanc	
	1289		■ Gris   Grey   Gris	
	1290		Ⓜ Color RAL RAL color   Couleur RAL	





## MILOS

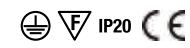

 **A+** LED 3W  
160 Lumens  
3.000 K

FLORÓN Y CUERPO TUBULAR EN GRIS, BLANCO,  
NEGRO O COLOR RAL

GREY, WHITE, BLACK OR RAL COLOR CEILING  
LAMP & TUBULAR BODY

PAVILLON ET CORPS TUBULAIRE EN GRIS, EN  
BLANC, EN NOIR OU EN COULEUR RAL

Diámetro cuerpo tubular 2,5 cm

Tubular body diameter 2,5 cm

Diamètre corps tubulaire 2,5 cm

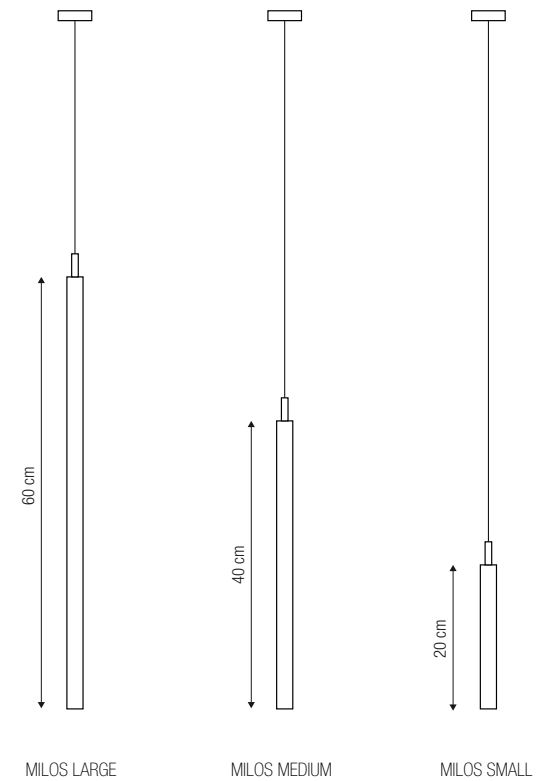

MILOS SMALL	MILOS MEDIUM	MILOS LARGE	FLORÓN CEILING ROSE PAVILLON	CUERPO TUBULAR TUBULAR BODY CORPS TUBULAIRE	CABLE CÂBLE CÂBLE
			● Negro   Black   Noir	■ Negro   Black   Noir	Algodón negro   Black cotton   Coton noir
			● Blanco   White   Blanc	■ Blanco   White   Blanc	Algodón blanco   White cotton   Coton blanc
			● Blanco   White   Blanc	■ Blanco   White   Blanc	Algodón negro   Black cotton   Coton noir
			● Gris   Grey   Gris	■ Gris   Grey   Gris	Algodón negro   Black cotton   Coton noir
			Ⓜ Color RAL RAL color   Couleur RAL	Ⓜ Color RAL RAL color   Couleur RAL	Algodón negro Black cotton   Coton noir
	1296		● Negro   Black   Noir	■ Negro   Black   Noir	Algodón negro   Black cotton   Coton noir
	1297		● Blanco   White   Blanc	■ Blanco   White   Blanc	Algodón blanco   White cotton   Coton blanc
	1298		● Blanco   White   Blanc	■ Blanco   White   Blanc	Algodón negro   Black cotton   Coton noir
	1299		● Gris   Grey   Gris	■ Gris   Grey   Gris	Algodón negro   Black cotton   Coton noir
	1300		Ⓜ Color RAL RAL color   Couleur RAL	Ⓜ Color RAL RAL color   Couleur RAL	Algodón negro Black cotton   Coton noir
		1301	● Negro   Black   Noir	■ Negro   Black   Noir	Algodón negro   Black cotton   Coton noir
		1302	● Blanco   White   Blanc	■ Blanco   White   Blanc	Algodón blanco   White cotton   Coton blanc
		1303	● Blanco   White   Blanc	■ Blanco   White   Blanc	Algodón negro   Black cotton   Coton noir
		1304	● Gris   Grey   Gris	■ Gris   Grey   Gris	Algodón negro   Black cotton   Coton noir
		1305	Ⓜ Color RAL RAL color   Couleur RAL	Ⓜ Color RAL RAL color   Couleur RAL	Algodón negro Black cotton   Coton noir





# MANHATTAN C

IP20 CE

LED 3W  
150 Lumens  
3.000 K

ESTRUCTURA EN NIQUEL, BLANCO O NEGRO  
NICKEL, WHITE OR BLACK STRUCTURE  
STRUCTURE EN NICKEL, EN BLANC OU EN NOIR

Foco articulado de diámetro 2,8 cm. Manhattan c/1 tija de 25/40/60/80 cm. Manhattan c/3 tijas de 25, 40 y 60 cm. Florón cuadrado de 22 cm  
Articulated spotlight of diameter 2,8 cm. Manhattan c/1 shank 25/40/60/80 cm. Manhattan c/3 shanks 25, 40 and 60 cm. Square ceiling rose 22 cm  
Spot articulé de diamètre 2,8 cm. Manhattan c/1 tige de 25/40/60/80 cm. Manhattan c/3 tiges de 25, 40 et 60 cm. Pavillon carrée 22 cm

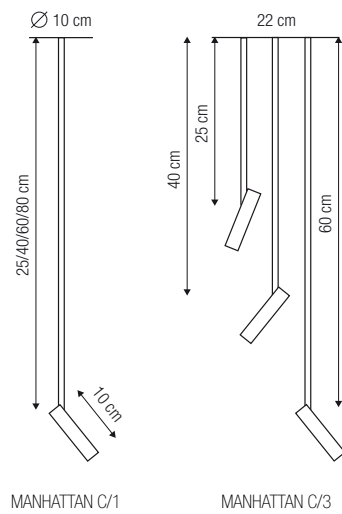

MANHATTAN C/1

MANHATTAN C/3



p. 294

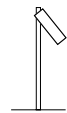

p. 242



p. 124

MANHATTAN C/1	MANHATTAN C/3	ESTRUCTURA STRUCTURE STRUCTURE	LONGITUD TIJA LONGUEUR TIGE
1000		● Negro   Black   Noir	25 cm
1001		● Negro   Black   Noir	40 cm
1002		● Negro   Black   Noir	60 cm
1003		● Negro   Black   Noir	80 cm
	1004	● Negro   Black   Noir	25, 40 y 60 cm
1005		● Blanco   White   Blanc	25 cm
1006		● Blanco   White   Blanc	40 cm
1007		● Blanco   White   Blanc	60 cm
1008		● Blanco   White   Blanc	80 cm
	1009	● Blanco   White   Blanc	25, 40 y 60 cm
1010		● Níquel   Nickel   Nickel	25 cm
1011		● Níquel   Nickel   Nickel	40 cm
1012		● Níquel   Nickel   Nickel	60 cm
1013		● Níquel   Nickel   Nickel	80 cm
	1014	● Níquel   Nickel   Nickel	25, 40 y 60 cm

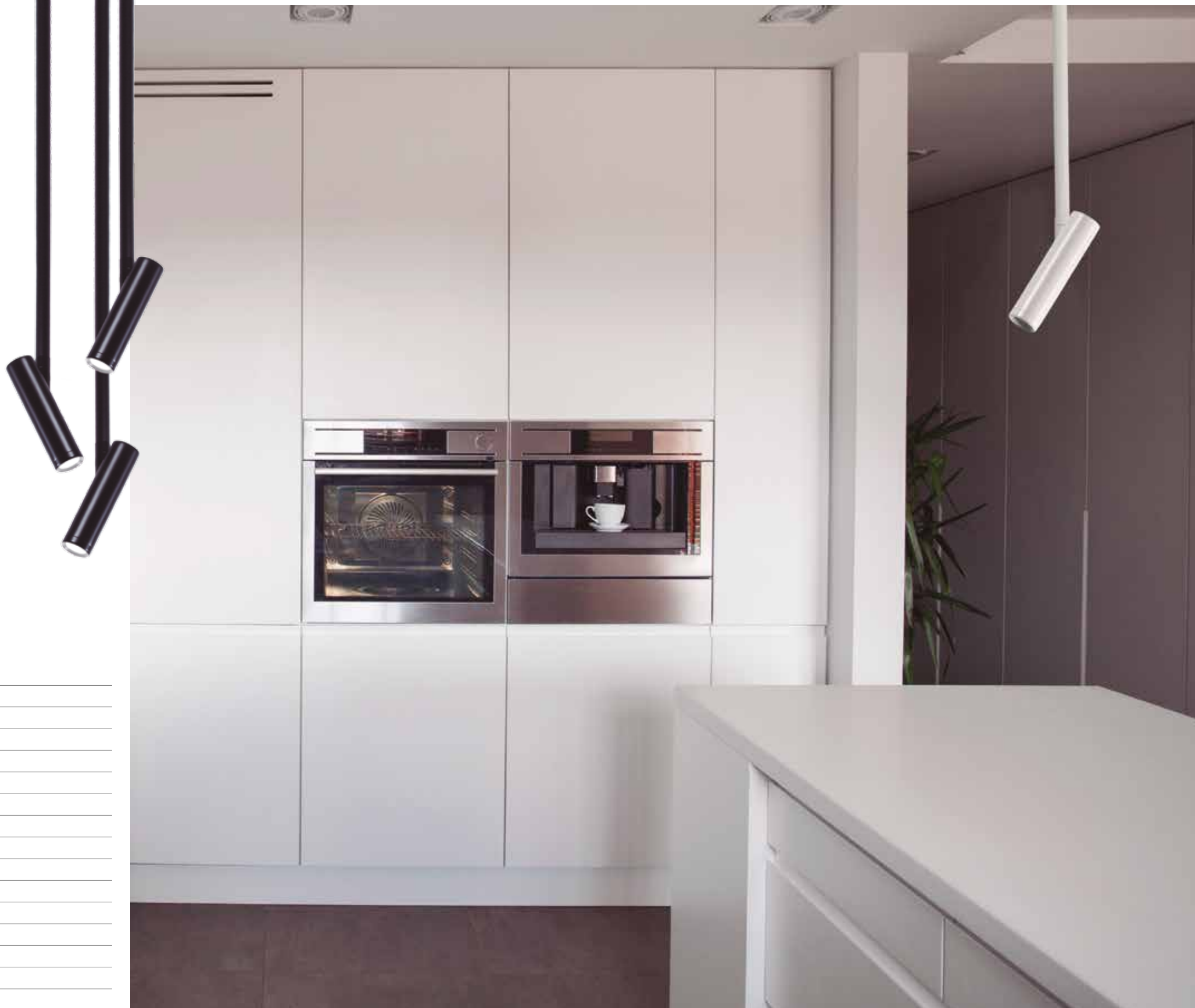

# THIRA



- Tira LED 18W (THIRA 86,5 cm) - 2.660 Lumens - 3.000 K
- Tira LED 24W (THIRA 114,5 cm) - 3.530 Lumens - 3.000 K

FLORÓN Y CUERPO RECTANGULAR EN GRIS,  
BLANCO, NEGRO O COLOR RAL

GREY, WHITE, BLACK OR RAL COLOR CEILING  
LAMP & RECTANGULAR BODY

PAVILLON ET CORPS RECTANGULAIRE EN GRIS, EN  
BLANC, EN NOIR OU EN COULEUR RAL

Disponible en dos medidas. Cables de suspensión  
ajustables de acero con autobloqueo

Available in two sizes. Adjustable self-locking steel  
suspension cables

Disponible en deux mesures. Câbles de suspension  
réglables en acier à verrouillage automatique

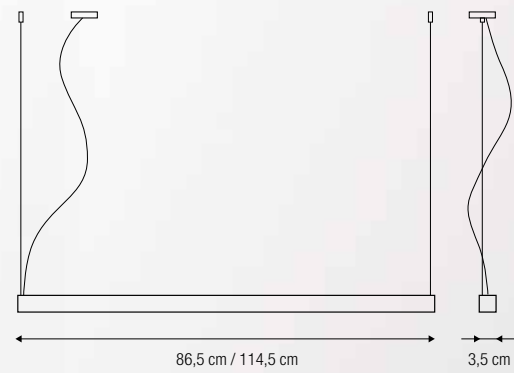

THIRA 86,5 CM	THIRA 114,5 CM	FLORÓN CEILING ROSE PAVILLON	CUERPO RECTANGULAR RECTANGULAR BODY CORPS RECTANGULAIRE	CABLE CABLE CÂBLE
1306	1311	● Negro   Black   Noir	■ Negro   Black   Noir	Algodón negro   Black cotton   Coton noir
1307	1312	● Blanco   White   Blanc	■ Blanco   White   Blanc	Algodón blanco   White cotton   Coton blanc
1308	1313	● Blanco   White   Blanc	■ Blanco   White   Blanc	Algodón negro   Black cotton   Coton noir
1309	1314	● Gris   Grey   Gris	■ Gris   Grey   Gris	Algodón negro   Black cotton   Coton noir
1310	1315	● RAL Color RAL RAL color   Couleur RAL	■ RAL Color RAL RAL color   Couleur RAL	Algodón negro Black cotton   Coton noir





# AIR



**A+** Tira LED 24W - 12V  
1.500 Lumens  
3.000 K

## ESTRUCTURA EN ALUMINIO

ALUMINIUM STRUCTURE

STRUCTURE EN ALUMINIUM

Disponible en cualquier medida hasta 200 cm

Available in any size until 200 cm

Disponible sur mesure jusqu'à 200 cm

Cables de suspensión ajustables de acero con autobloqueo

Adjustable self-locking steel suspension cables

Câbles de suspension réglables en acier à verrouillage automatique

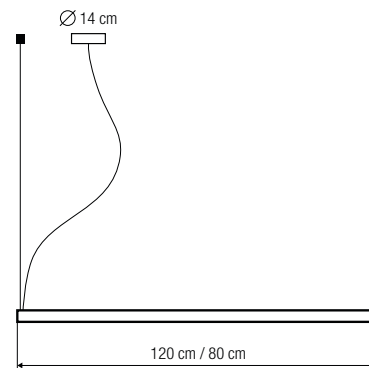

AIR 80 CM	AIR 120 CM	ESTRUCTURA STRUCTURE STRUCTURE	CABLE CABLE CÂBLE
1280	1281	Aluminio Aluminium   Aluminium	Transparente Transparent   Transparent

# BOSTON



max. 11 W | GX53  
 1 x GX-53 LED 11W

FLORÓN EN NÍQUEL, BLANCO O NEGRO  
 NICKEL, WHITE OR BLACK CEILING ROSE  
 PAVILLON EN NICKEL, EN BLANC OU EN NOIR

GLOBO DE CRISTAL TRANSPARENTE  
 TRANSPARENT GLASS GLOBE  
 GLOBE TRANSPARENT EN VERRE

Diámetro globo 25 cm  
 Globe diameter 25 cm  
 Diamètre globe 25 cm

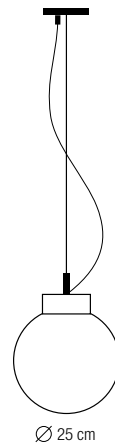

	FLORÓN CEILING ROSE PAVILLON	CABLE CABLE CÂBLE
1328	● Negro   Black   Noir	PVC negro   Black PVC   PVC noir
1329	● Blanco   White   Blanc	Transparent   Transparent   Transparent
1330	● Níquel   Nickel   Nickel	Transparent   Transparent   Transparent



# MOON c



max. 42 W | E27

- A+** 1 x E-27 LED 12W
- A** 1 x E-27 FLC 25W
- B** 1 x E-27 A60 ECO 42W

FLORÓN Y ESTRUCTURA EN NÍQUEL, ÓXIDO, BLANCO O NEGRO. GLOBO OPAL TRIPLEX  
 NICKEL, OXIDE, WHITE OR BLACK CEILING ROSE & STRUCTURE. GLOBE OPAL TRIPLEX  
 PAVILLON ET STRUCTURE EN NICKEL, EN OXYDE, EN BLANC OU EN NOIR. GLOBE OPAL TRIPLEX

Globo en forma esférica o elíptica. Cables de suspensión ajustables de acero con autobloqueo  
 Spherical or elliptical globe. Adjustable self-locking steel suspension cables  
 Globe en forme sphérique ou elliptique. Câbles de suspension réglables en acier à verrouillage automatique

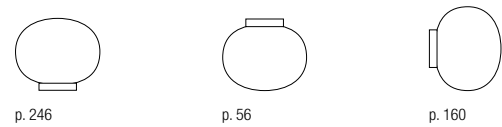
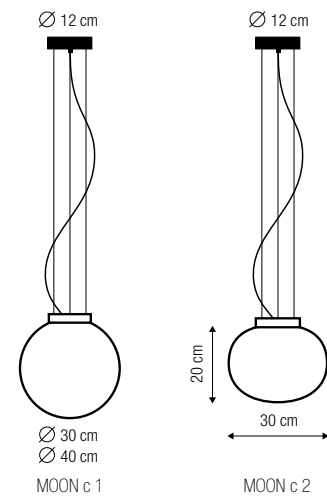

MOON c 1 Ø 30 CM	MOON c 1 Ø 40 CM	MOON c 2	FLORÓN CEILING ROSE PAVILLON	ESTRUCTURA STRUCTURE STRUCTURE	CABLE CABLE CÂBLE
1250	1254	1258	Blanco White   Blanc	Blanco White   Blanc	Algodón blanco White cotton   Coton blanc
1251	1255	1259	Negro Black   Noir	Negro Black   Noir	Algodón negro Black cotton   Coton noir
1252	1256	1260	Óxido Oxide   Oxyde	Óxido Oxide   Oxyde	Algodón marrón Brown cotton   Coton marron
1253	1257	1261	Níquel Nickel   Nickel	Níquel Nickel   Nickel	Transparente Transparent   Transparent

# MOON pl



max. 42 W | E27

- A+** 1 x E-27 LED 12W      2 x E-27 LED 12W
  - A** 1 x E-27 FLC 25W      2 x E-27 FLC 25W
  - B** 1 x E-27 A60 ECO 42W    2 x E-27 A60 ECO 42W
- Moon 1/Moon 2                  Moon 3

FLORÓN EN NÍQUEL, ÓXIDO, BLANCO O NEGRO.

GLOBO OPAL TRIPLEX

NICKEL, OXIDE, WHITE OR BLACK CEILING ROSE.

GLOBE OPAL TRIPLEX

PAVILLON EN NICKEL, EN OXYDE, EN BLANC OU EN NOIR. GLOBE OPAL TRIPLEX

Globo en forma esférica o elíptica

Spherical or elliptical globe

Globe en forme sphérique ou elliptique

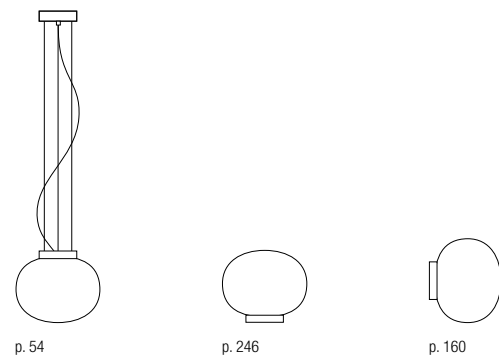
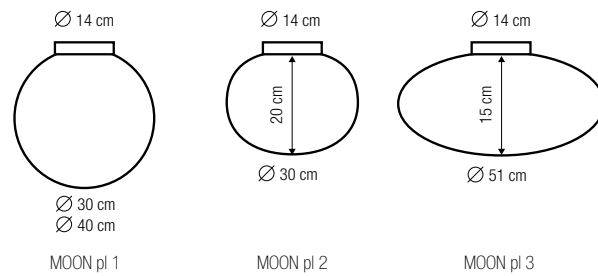

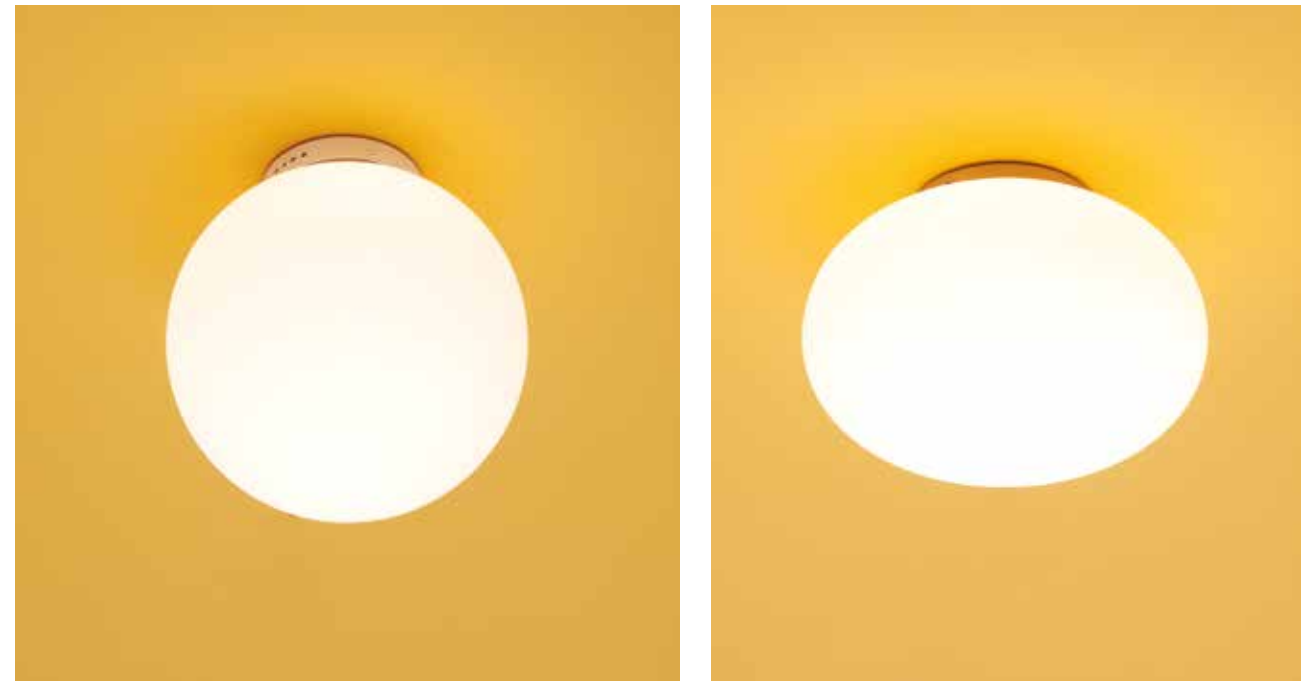

MOON pl 1 Ø 30 CM	MOON pl 1 Ø 40 CM	MOON pl 2	MOON pl 3	FLORÓN PAVILLON CEILING ROSE
1262	1266	1270	1274	Blanco <i>White   Blanc</i>
1263	1267	1271	1275	Negro <i>Black   Noir</i>
1264	1268	1272	1276	Óxido <i>Oxide   Oxyde</i>
1265	1269	1273	1277	Níquel <i>Nickel   Nickel</i>



# RONDO

IP20 CE

max. 42 W | E27

-  **A+** 3 x E-27 LED 12W
-  **A** 3 x E-27 FLC 25W
-  **B** 3 x E-27 A60 ECO 42W

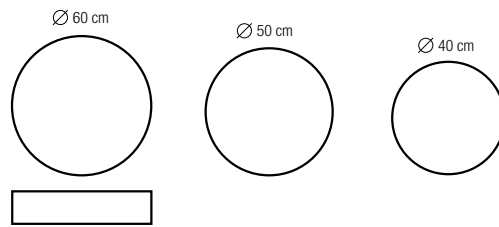

PANTALLA DE LONETA, ARPILLERA, COTONET, OSAKA O LINBA

COTTON, SACKING, COTONET, OSAKA OR LINBA  
LAMP SHADE

ABAT-JOUR EN COTON, EN TOILE, EN COTONET, EN OSAKA OU EN LINBA

Pantalla 40 x 14 x 40 cm, 50 x 14 x 50 cm o 60 x 14 x 60 cm. Medidas especiales disponibles (hasta 150 cm)

Lampshade 40 x 14 x 40 cm, 50 x 14 x 50 cm o 60 x 14 x 60 cm. Special sizes available (up to 150 cm)

Abat-jour 40 x 14 x 40 cm, 50 x 14 x 50 cm o 60 x 14 x 60 cm. Dimensions spéciales disponibles (jusqu'à 150 cm)



RONDO 40 CM	RONDO 50 CM	RONDO 60 CM	PANTALLA LAMP SHADE ABAT-JOUR
1064	1077	1090	Loneta   Cotton   Coton
1065	1078	1091	Loneta blanca   White cotton   Coton blanc
1066	1079	1092	Osaka
1067	1080	1093	Arpillera beige   Beige sacking   Toile beige
1068	1081	1094	Saco   Sack   Jute
1069	1082	1095	Chintz morado   Purple chintz   Chintz violet
1070	1083	1096	Cotonet topo   Taupe cotonet   Cotonet taupe
1071	1084	1097	Cotonet arena   Sand cotonet   Cotonet sable
1072	1085	1098	Cotonet blanco   White cotonet   Cotonet blanc
1073	1086	1099	Cotonet beige   Beige cotonet   Cotonet beige
1074	1087	1100	Cotonet negro   Black cotonet   Cotonet noir
1075	1088	1101	Cotonet antracita   Anthracite cotonet   Cotonet anthracite
1076	1089	1102	Linba marrón   Brown linba   Linba marron

# CUADRO

IP20 CE

max. 42 W | E27

**A+** 3 x E-27 LED 12W

**A** 3 x E-27 FLC 25W

**B** 3 x E-27 A60 ECO 42W

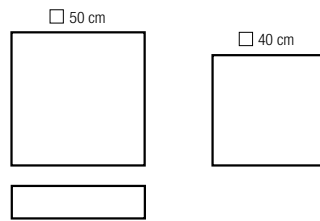

PANTALLA DE LONETA, ARPILLERA, COTONET, OSAKA O LINBA

COTTON, SACKING, COTONET, OSAKA OR LINBA LAMPSHADE

ABAT-JOUR EN COTON, EN TOILE, EN COTONET, EN OSAKA OU EN LINBA

Pantalla 40 x 14 x 40 cm o 50 x 14 x 50 cm.

Medidas especiales disponibles (hasta 150 cm)

Lampshade 40 x 14 x 40 cm o 50 x 14 x 50 cm.

Special sizes available (up to 150 cm)

Abat-jour 40 x 14 x 40 cm o 50 x 14 x 50 cm.

Dimensions spéciales disponibles (jusqu'à 150 cm)

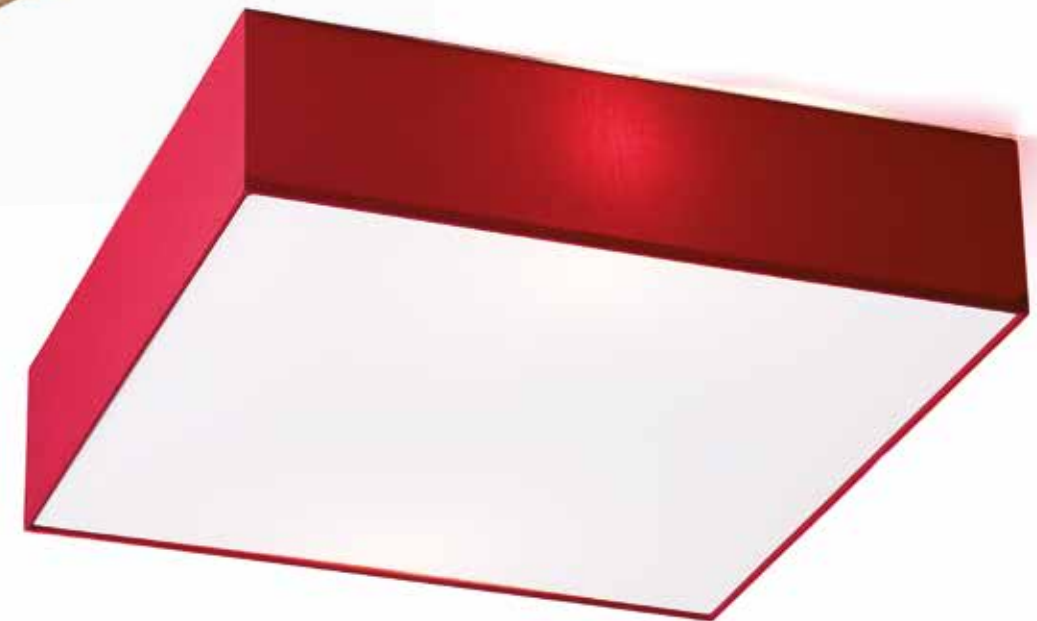



RONDO 40 CM	RONDO 50 CM	PANTALLA LAMPSHADE ABAT-JOUR
1103	1116	Loneta   Cotton   Coton
1104	1117	Loneta blanca   White cotton   Coton blanc
1105	1118	Osaka
1106	1119	Arpillera beige   Beige sacking   Toile beige
1107	1120	Saco   Sack   Jute
1108	1121	Chintz morado   Purple chintz   Chintz violet
1109	1122	Cotonet topo   Taupe cotonet   Cotonet taupe
1110	1123	Cotonet arena   Sand cotonet   Cotonet sable
1111	1124	Cotonet blanco   White cotonet   Cotonet blanc
1112	1125	Cotonet beige   Beige cotonet   Cotonet beige
1113	1126	Cotonet negro   Black cotonet   Cotonet noir
1114	1127	Cotonet antracita   Anthracite cotonet   Cotonet anthracite
1115	1128	Linba marrón   Brown linba   Linba marron

# TREBOL

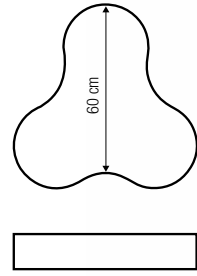
IP20 CE



max. 42 W | E27

-  **A+** 3 x E-27 LED 12W
-  **A** 3 x E-27 FLC 25W
-  **B** 3 x E-27 A60 ECO 42W

PANTALLA DE COTONET, OSAKA O CHINTZ

COTONET, OSAKA OR CHINTZ LAMPSHADE









ABAT-JOUR EN COTONET, EN OSAKA OU EN CHINTZ

Pantalla 60 x 14 x 60

Lampshade 60 x 14 x 60

Abat-jour 60 x 14 x 60

PANTALLA  
LAMPSHADE  
ABAT-JOUR

1029		Cotonet blanco   <i>White cotonet</i>   Cotonet blanc
1030		Cotonet beige   <i>Beige cotonet</i>   Cotonet beige
1031		Osaka
1032		Chintz verde   <i>Green chintz</i>   Chintz vert
1033		Chintz rojo   <i>Red chintz</i>   Chintz rouge
1034		Chintz naranja   <i>Orange chintz</i>   Chintz orange
1035		Chintz morado   <i>Purple chintz</i>   Chintz violet
1036		Chintz gris   <i>Grey chintz</i>   Chintz gris

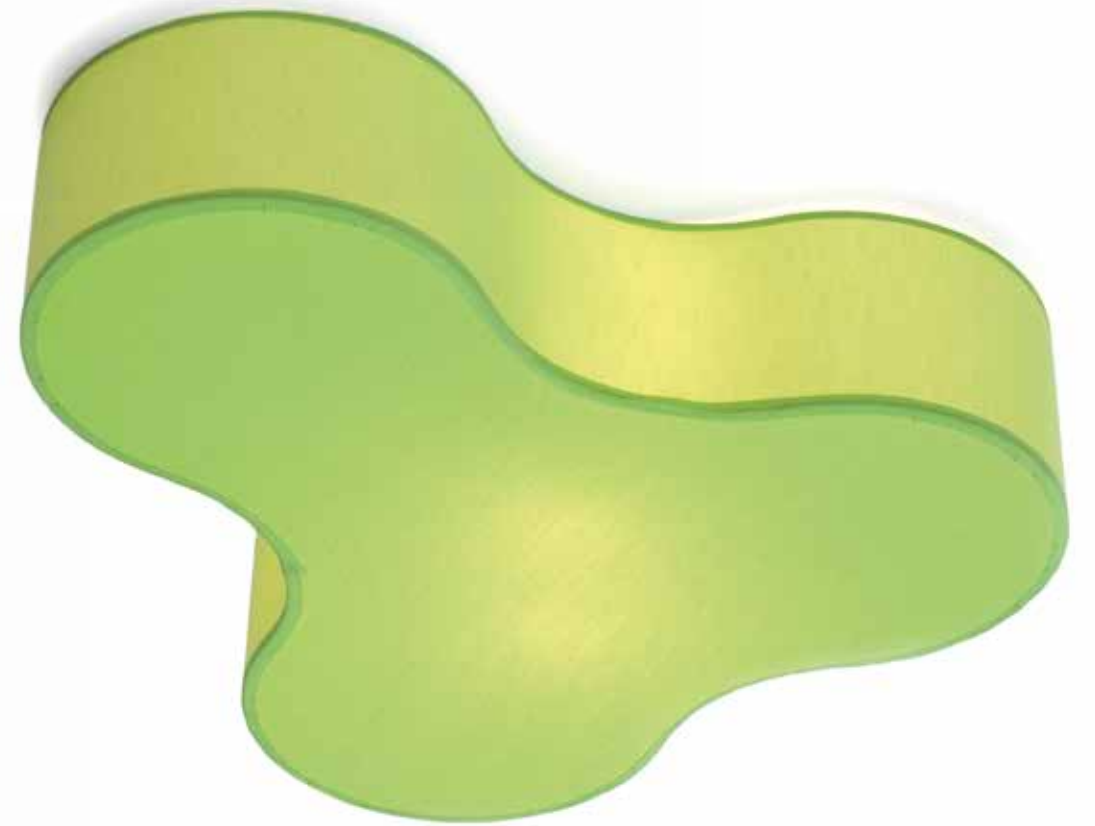
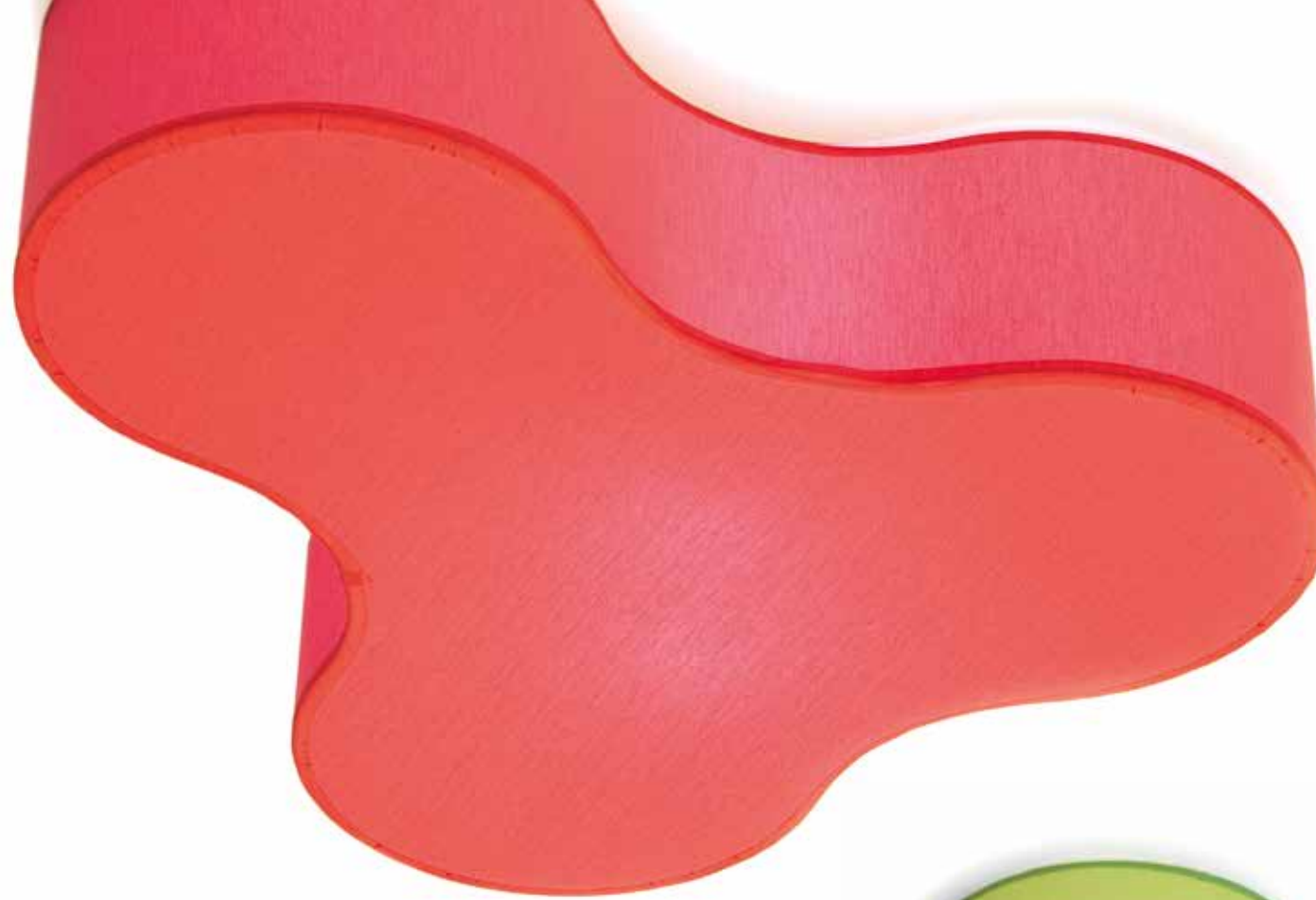

# PARIS



max. 42 W | E27

- A+** 3 x E-27 LED 12W
- A** 3 x E-27 FLC 25W
- B** 3 x E-27 A60 ECO 42W

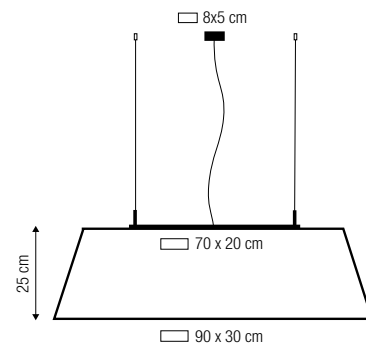

ESTRUCTURA EN ÓXIDO O NÍQUEL

*OXIDE OR NICKEL STRUCTURE*

STRUCTURE EN OXYDE OU EN NICKEL

PANTALLA DE LONETA, ARPILLERA, OSAKA O COTONET

*COTTON, SACKING, OSAKA OR COTONET*

LAMP SHADE

ABAT-JOUR EN COTON, EN TOILE, EN OSAKA OU EN COTONET

Pantalla trapezoidal base 90 x 30 cm y altura 25 cm

*Trapezoidal lampshade base 90 x 30 cm and height 25 cm*

Abat-jour trapézoïdale base 90 x 30 cm et hauteur 25 cm

	ESTRUCTURA STRUCTURE STRUCTURE	PANTALLA LAMP SHADE ABAT-JOUR	CABLE CABLE CÂBLE
1137	Níquel <i>Nickel   Nickel</i>	Loneta <i>Cotton   Coton</i>	Transparente <i>Transparent   Transparent</i>
1138	Níquel <i>Nickel   Nickel</i>	Osaka	Transparente <i>Transparent   Transparent</i>
1139	Níquel <i>Nickel   Nickel</i>	Cotonet topo <i>Taupe cotonet   Cotonet taupe</i>	Transparente <i>Transparent   Transparent</i>
1140	Níquel <i>Nickel   Nickel</i>	Cotonet arena <i>Sand cotonet   Cotonet sable</i>	Transparente <i>Transparent   Transparent</i>
1141	Níquel <i>Nickel   Nickel</i>	Cotonet blanco <i>White cotonet   Cotonet blanc</i>	Transparente <i>Transparent   Transparent</i>
1142	Níquel <i>Nickel   Nickel</i>	Cotonet beige <i>Beige cotonet   Cotonet beige</i>	Transparente <i>Transparent   Transparent</i>
1143	Óxido <i>Oxide   Oxyde</i>	Loneta <i>Cotton   Coton</i>	Algodón marrón <i>Brown cotton   Coton marron</i>
1144	Óxido <i>Oxide   Oxyde</i>	Osaka	Algodón marrón <i>Brown cotton   Coton marron</i>
1145	Óxido <i>Oxide   Oxyde</i>	Arpillera beige <i>Beige sacking   Toile beige</i>	Algodón marrón <i>Brown cotton   Coton marron</i>
1146	Óxido <i>Oxide   Oxyde</i>	Loneta <i>Cotton   Coton</i>	Algodón marrón <i>Brown cotton   Coton marron</i>
1147	Óxido <i>Oxide   Oxyde</i>	Loneta blanca <i>White cotton   Coton blanc</i>	Algodón marrón <i>Brown cotton   Coton marron</i>
1148	Óxido <i>Oxide   Oxyde</i>	Cotonet beige <i>Beige cotonet   Cotonet beige</i>	Algodón marrón <i>Brown cotton   Coton marron</i>





# UFO

IP20 CE

max. 42 W | E27

- A+** 3 x E-27 LED 12W
- A** 3 x E-27 FLC 25W
- B** 3 x E-27 A60 ECO 42W

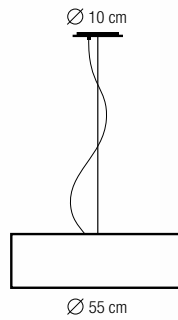

FLORÓN EN ÓXIDO, NEGRO O NÍQUEL

OXIDE, BLACK OR NICKEL CEILING ROSE

PAVILLON EN OXYDE, EN NOIR OU EN NICKEL

PANTALLA DE LONETA, ARPILLERA, COTONET, OSAKA, SCREEN O LINBA

COTTON, SACKING, COTONET, OSAKA, SCREEN OR LINBA LAMP SHADE

ABAT-JOUR EN COTON, EN TOILE, EN COTONET, EN OSAKA, EN SCREEN OU EN LINBA

Pantalla de 55 x 17 x 55 cm. Preguntar para medidas especiales (hasta diámetro 150 cm)

Lampshade 55 x 17 x 55 cm. Ask for special sizes (up to diameter 150 cm)

Demander pour des mesures spéciales (jusqu'à diamètre 150 cm)

	ESTRUCTURA STRUCTURE STRUCTURE	PANTALLA LAMP SHADE ABAT-JOUR	CABLE CABLE CÂBLE
1161	Níquel <i>Nickel   Nickel</i>	Loneta blanca <i>White cotton   Coton blanc</i>	Transparente <i>Transparent   Transparent</i>
1162	Níquel <i>Nickel   Nickel</i>	Osaka	Transparente <i>Transparent   Transparent</i>
1163	Níquel <i>Nickel   Nickel</i>	Cotonet topo <i>Taupe cotonet   Cotonet taupe</i>	Transparente <i>Transparent   Transparent</i>
1164	Níquel <i>Nickel   Nickel</i>	Cotonet blanco <i>White cotonet   Cotonet blanc</i>	Transparente <i>Transparent   Transparent</i>
1165	Níquel <i>Nickel   Nickel</i>	Screen blanco <i>White screen   Screen blanc</i>	Transparente <i>Transparent   Transparent</i>
1166	Níquel <i>Nickel   Nickel</i>	Screen beige <i>Beige screen   Screen beige</i>	Transparente <i>Transparent   Transparent</i>
1167	Óxido <i>Oxide   Oxyde</i>	Loneta <i>Cotton   Coton</i>	Algodón marrón <i>Brown cotton   Coton marron</i>
1168	Óxido <i>Oxide   Oxyde</i>	Osaka	Algodón marrón <i>Brown cotton   Coton marron</i>
1169	Óxido <i>Oxide   Oxyde</i>	Saco <i>Sack   Jute</i>	Algodón marrón <i>Brown cotton   Coton marron</i>
1170	Óxido <i>Oxide   Oxyde</i>	Arpillera beige <i>Beige sacking   Toile beige</i>	Algodón marrón <i>Brown cotton   Coton marron</i>
1171	Óxido <i>Oxide   Oxyde</i>	Linba marrón <i>Brown linba   Linba marron</i>	Algodón marrón <i>Brown cotton   Coton marron</i>
1172	Negro <i>Black   Noir</i>	Cotonet negro <i>Black cotonet   Cotonet noir</i>	Algodón negro <i>Black cotton   Coton noir</i>
1173	Negro <i>Black   Noir</i>	Cotonet antracita <i>Anthracite cotonet   Cotonet anthracite</i>	Algodón negro <i>Black cotton   Coton noir</i>
1174	Negro <i>Black   Noir</i>	Screen marrón <i>Brown screen   Screen marron</i>	Algodón negro <i>Black cotton   Coton noir</i>





# ARCO C



max. 42 W | E27

- A+** 1 x E-27 LED 12W
- A** 1 x E-27 FLC 25W
- B** 1 x E-27 A60 ECO 42W

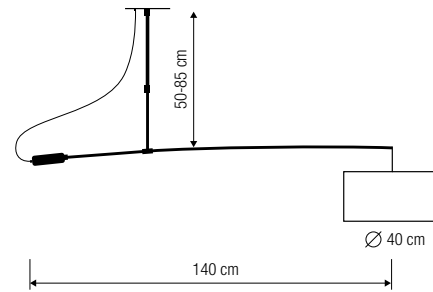

ESTRUCTURA EN ÓXIDO, NEGRO O NÍQUEL

OXIDE, BLACK OR NICKEL STRUCTURE

STRUCTURE EN OXYDE, EN NOIR OU EN NICKEL

PANTALLA DE LONETA, ARPILLERA, COTONET, OSAKA O LINBA

COTTON, SACKING, COTONET, OSAKA OR LINBA LAMP SHADE

ABAT-JOUR EN COTON, EN TOILE, EN COTONET, EN OSAKA OU EN LINBA

Pantalla 40 x 20 X 40 cm

Lampshade 40 x 20 x 40 cm

Abat-jour 40 x 20 x 40 cm

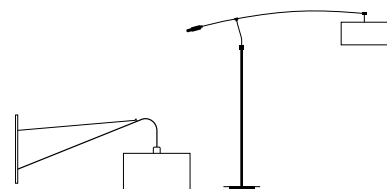

p. 180

p. 302

	ESTRUCTURA STRUCTURE STRUCTURE	PANTALLA LAMP SHADE ABAT-JOUR	CABLE CABLE CÂBLE
1149	Níquel <i>Nickel   Nickel</i>	Loneta blanca <i>White cotton   Coton blanc</i>	Transparente <i>Transparent   Transparent</i>
1150	Níquel <i>Nickel   Nickel</i>	Osaka	Transparente <i>Transparent   Transparent</i>
1151	Níquel <i>Nickel   Nickel</i>	Cotonet topo <i>Taupe cotonet   Cotonet taupe</i>	Transparente <i>Transparent   Transparent</i>
1152	Níquel <i>Nickel   Nickel</i>	Cotonet blanco <i>White cotonet   Cotonet blanc</i>	Transparente <i>Transparent   Transparent</i>
1153	Níquel <i>Nickel   Nickel</i>	Linba marrón <i>Brown linba   Linba marron</i>	Transparente <i>Transparent   Transparent</i>
1154	Óxido <i>Oxide   Oxyde</i>	Loneta <i>Cotton   Coton</i>	Algodón marrón <i>Brown cotton   Coton marron</i>
1155	Óxido <i>Oxide   Oxyde</i>	Osaka	Algodón marrón <i>Brown cotton   Coton marron</i>
1156	Óxido <i>Oxide   Oxyde</i>	Saco <i>Sack   Jute</i>	Algodón marrón <i>Brown cotton   Coton marron</i>
1157	Óxido <i>Oxide   Oxyde</i>	Arpillera beige <i>Beige sacking   Toile beige</i>	Algodón marrón <i>Brown cotton   Coton marron</i>
1158	Óxido <i>Oxide   Oxyde</i>	Linba marrón <i>Brown linba   Linba marron</i>	Algodón marrón <i>Brown cotton   Coton marron</i>
1159	Negro <i>Black   Noir</i>	Cotonet negro <i>Black cotonet   Cotonet noir</i>	Algodón negro <i>Black cotton   Coton noir</i>
1160	Negro <i>Black   Noir</i>	Cotonet antracita <i>Anthracite cotonet   Cotonet anthracite</i>	Algodón negro <i>Black cotton   Coton noir</i>



# OSLO



max. 42 W | E27

- A+** 1 x E-27 LED 12W
- A** 1 x E-27 FLC 25W
- B** 1 x E-27 A60 ECO 42W

ESTRUCTURA EN ÓXIDO Y ARPILLERA O EN NÍQUEL Y PIEL

*OXIDE AND SACKING OR NICKEL AND LEATHER STRUCTURE*

STRUCTURE EN OXYDE ET TOILE OU EN NICKEL ET CUIR

PANTALLA DE LONETA O ARPILLERA

*COTTON OR SACKING LAMPSHADE*

ABAT-JOUR EN COTON OU EN TOILE

Altura regulable con sistema de contrapeso y poleas.  
Pantalla 40 x 20 x 40 cm

*Adjustable height with counterweight system and pulleys. Lampshade 40 x 20 x 40 cm*

Hauteur réglable avec système de contrepoids et poulies. Abat-jour 40 x 20 x 40 cm

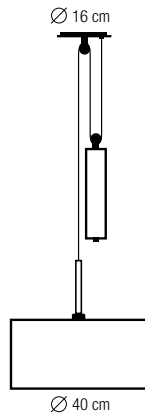



	ESTRUCTURA STRUCTURE STRUCTURE	PANTALLA LAMPSHADE ABAT-JOUR	CABLE CABLE CÂBLE
1175	Níquel y piel <i>Nickel and leather</i> Nickel et cuir	Loneta <i>Cotton</i> Coton	Transparente <i>Transparent</i> Transparent
1176	Óxido y arpillera <i>Oxide &amp; sacking</i> Oxyde et toile	Arpillera beige <i>Beige sacking</i> Toile beige	Trenzado marrón <i>Brown braided</i> Torsadé marron
1177	Óxido y arpillera marrón <i>Oxide &amp; brown sacking</i> Oxyde et toile marron	Saco <i>Sack</i> Jute	Trenzado marrón <i>Brown braided</i> Torsadé marron

# MADISON

IP20 CE

max. 42 W | E27

-  **A+** 1 x E-27 LED 12W
-  **A** 1 x E-27 FLC 25W
-  **B** 1 x E-27 A60 ECO 42W

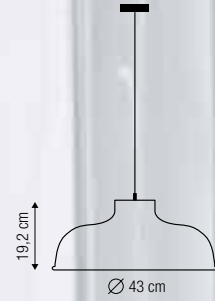

FLORÓN EN BLANCO, NEGRO O EN COLOR RAL

CEILING ROSE IN WHITE, BLACK OR IN RAL COLOUR

PAVILLON EN BLANC, EN NOIR OU EN COULEUR RAL

PANTALLA METÁLICA MONOCOLOR EN BLANCO, NEGRO O EN COLOR RAL

ONE-COLOUR METALLIC LAMP SHADE IN WHITE, BLACK OR IN RAL COLOUR

ABAT-JOUR MÉTALLIQUE UNICOLEUR EN BLANC, EN NOIR OU EN COULEUR RAL



	FLORÓN CEILING ROSE PAVILLON	PANTALLA LAMP SHADE ABAT-JOUR	CABLE CABLE CÂBLE
1023	 Negro Black   Noir	 Negro Black   Noir	PVC negro Black PVC   PVC noir
1024	 Blanco White   Blanc	 Blanco White   Blanc	PVC negro Black PVC   PVC noir
1025	 Color RAL RAL color   Couleur RAL	 Color RAL RAL color   Couleur RAL	PVC negro Black PVC   PVC noir



# ASTORIA

IP20 CE

max. 42 W | E27

-  **A+** 1 x E-27 LED 12W
-  **A** 1 x E-27 FLC 25W
-  **B** 1 x E-27 A60 ECO 42W

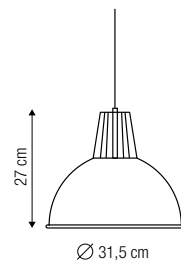

Ø 31,5 cm

ASTORIA SMALL

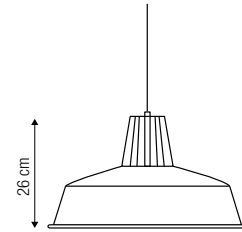

Ø 47,5 cm

ASTORIA LARGE

FLORÓN EN BLANCO, NEGRO, ÓXIDO O EN COLOR RAL

CEILING ROSE IN WHITE, BLACK, OXIDE OR IN RAL COLOUR

PAVILLON EN BLANC, EN NOIR, EN OXYDE OU EN COULEUR RAL

PANTALLA METÁLICA MONOCOLOR EN BLANCO, NEGRO, ÓXIDO O EN COLOR RAL

ONE COLOUR METALLIC LAMPSHADE IN WHITE, BLACK, OXIDE OR IN RAL COLOUR









ABAT-JOUR MÉTALLIQUE INICOLEUR EN BLANC, EN NOIR, EN OXYDE OU EN COULEUR RAL

Disponible en dos medidas. Diámetros 31,5 cm y 47,5 cm

Available in two sizes. Diameters 31,5 cm and 47,5 cm

Disponible en deux mesures. Diamètres 31,5 cm et 47,5 cm



ASTORIA SMALL	ASTORIA LARGE	FLORÓN CEILING ROSE PAVILLON	PANTALLA LAMPSHADE ABAT-JOUR	CABLE CABLE CÂBLE
1316	1320	 Negro Black   Noir	 Negro Black   Noir	PVC negro Black PVC   PVC noir
1317	1321	 Óxido Oxide   Oxyde	 Óxido Oxide   Oxyde	PVC negro Black PVC   PVC noir
1318	1322	 Blanco White   Blanc	 Blanco White   Blanc	PVC negro Black PVC   PVC noir
1319	1323	 Color RAL RAL color   Couleur RAL	 Color RAL RAL color   Couleur RAL	PVC negro Black PVC   PVC noir











# AURA

IP20 CE

max. 42 W | E27

-  **A+** 1 x E-27 LED 12W
-  **A** 1 x E-27 FLC 25W
-  **B** 1 x E-27 A60 ECO 42W

 **A+** Tira LED 25W - 24V  
1.400 Lumens  
3.000 K  
(Aura)

Tira LED 18W - 24V  
940 Lumens  
3.000 K  
(Aura mini)

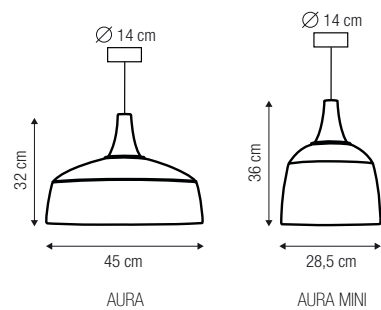



## FLORÓN Y PANTALLA EN BLANCO O NEGRO

WHITE OR BLACK CEILING ROSE & LAMP SHADE

PAVILLON ET ABAT-JOUR EN BLANC OU EN NOIR



AURA LED	AURA MINI LED	AURA E-27	AURA MINI E-27	FLORÓN Y PANTALLA CEILING ROSE & LAMP SHADE PAVILLON ET ABAT-JOUR	CABLE CABLE CÂBLE
1241	1243	1324	1326	 Negro Black   Noir	Algodón negro Black cotton   Coton noir
1242	1244	1325	1327	 Blanco White   Blanc	Algodón negro Black cotton   Coton noir



# GABIA

IP20 CE

**A+** Tira LED 25W - 24V  
1.450 Lumens  
3.000 K

FLORÓN Y PANTALLA EN BLANCO O NEGRO  
WHITE OR BLACK CEILING ROSE & LAMP SHADE  
PAVILLON ET ABAT-JOUR EN BLANC OU EN NOIR

Cable de suspensión ajustable de acero con autobloqueo  
Adjustable self-locking steel suspension cable  
Câble de suspension réglable en acier à verrouillage automatique

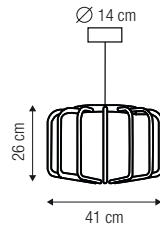

FLORÓN Y PANTALLA  
CEILING ROSE & LAMP SHADE  
PAVILLON ET ABAT-JOUR

CABLE  
CABLE  
CÂBLE

1239	● Negro Black   Noir	Algodón negro Black cotton   Coton noir
1240	● Blanco White   Blanc	Algodón negro Black cotton   Coton noir

# CAPUCHINA C

IP20 CE

max. 42 W | E14

-  1 x E-14 LED 12W
-  1 x E-14 FLC 25W
-  1 x E-14 A60 ECO 42W

FLORÓN EN BLANCO, ÓXIDO O NEGRO

WHITE, OXIDE OR BLACK CEILING ROSE

PAVILLON EN BLANC, EN OXYDE OU EN NOIR

PANTALLA EN ÓXIDO (INTERIOR BLANCO), NEGRO

(INTERIOR DORADO) O BLANCO

OXIDE (WHITE INSIDE), BLACK (GOLDEN INSIDE)

OR WHITE LAMPSHADE

ABAT-JOUR EN OXYDE (INTÉRIEUR BLANC), EN







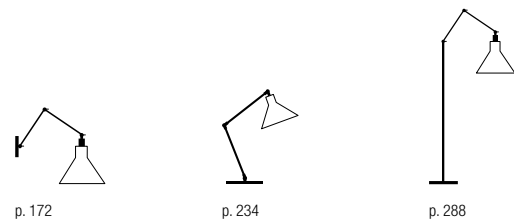
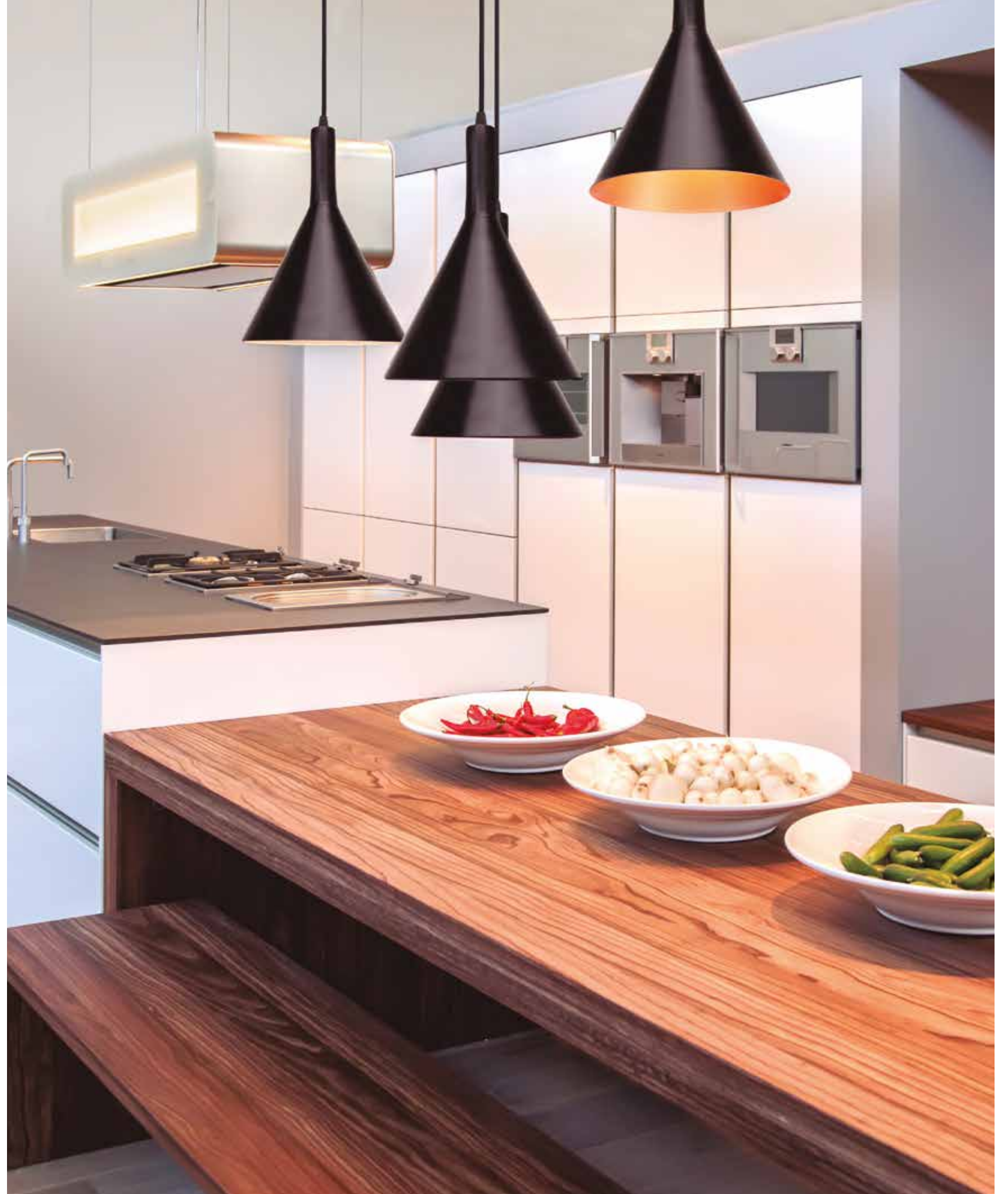
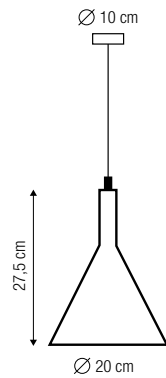

NOIR (INTÉRIEUR DORÉ) OU BLANC

Diámetro 20 cm

Diameter 20 cm

Diamètre 20 cm



	FLORÓN CEILING ROSE PAVILLON	PANTALLA LAMPSHADE ABAT-JOUR	CABLE CABLE CÂBLE
1246	 Negro Black   Noir	 Negro/dorado Black/golden   Noir/dorée	Algodón negro Black cotton   Coton noir
1247	 Negro Black   Noir	 Negro/blanco Black/white   Noir/blanc	Algodón negro Black cotton   Coton noir
1248	 Óxido Oxide   Oxyde	 Óxido/blanco Oxide/white   Oxyde/blanc	Algodón marrón Brown cotton   Coton marron
1249	 Blanco White   Blanc	 Blanco White   Blanc	Algodón blanco White cotton   Coton blanc

# SOHO C

IP20 CE

max. 42 W | E27

A+ 1 x E-27 LED 12W

A 1 x E-27 vintage LED 8W

B 1 x E-27 vintage Edison 40W

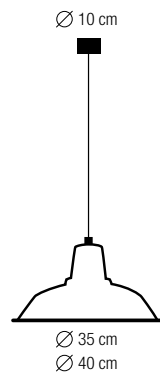

FLORÓN EN BLANCO, NEGRO, ÓXIDO O EN COLOR RAL

CEILING ROSE IN WHITE, BLACK, OXIDE OR IN RAL COLOUR

PAVILLON EN BLANC, EN NOIR, EN OXYDE OU EN COULEUR RAL

PANTALLA METÁLICA EN BLANCO, NEGRO, ÓXIDO O EN COLOR RAL

METALLIC LAMPSHADE IN WHITE, BLACK, OXIDE OR IN RAL COLOUR

ABAT-JOUR MÉTALLIQUE EN BLANC, EN NOIR, EN OXYDE OU EN COULEUR RAL

Diámetro 35 o 40 cm. Disponible con cable o con cadena

Diameter 35 or 40 cm. Available with cable or chain

Diamètre 35 ou 40 cm. Disponible avec câble ou avec chaîne

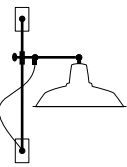

p. 176

SOHO 35 CM	SOHO 40 CM	FLORÓN CEILING ROSE PAVILLON	PANTALLA LAMPSHADE ABAT-JOUR	CABLE CABLE CÂBLE
1178	1186	● Negro Black   Noir	■ Negro Black   Noir	PVC negro Black PVC   PVC noir
1179	1187	● Negro Black   Noir	■ Negro Black   Noir	PVC negro con cadena Black PVC with chain   PVC noir avec chaîne
1180	1188	● Blanco White   Blanc	■ Blanco White   Blanc	PVC negro Black PVC   PVC noir
1181	1189	● Blanco White   Blanc	■ Blanco White   Blanc	PVC negro con cadena Black PVC with chain   PVC noir avec chaîne
1182	1190	● Óxido Oxide   Oxyde	■ Óxido Oxide   Oxyde	PVC negro Black PVC   PVC noir
1183	1191	● Óxido Oxide   Oxyde	■ Óxido Oxide   Oxyde	PVC negro con cadena Black PVC with chain   PVC noir avec chaîne
1184	1192	◻ Color RAL RAL color   Couleur RAL	◻ Color RAL RAL color   Couleur RAL	PVC negro Black PVC   PVC noir
1185	1193	◻ Color RAL RAL color   Couleur RAL	◻ Color RAL RAL color   Couleur RAL	PVC negro con cadena Black PVC with chain   PVC noir avec chaîne





# HARLEM

IP20 CE

max. 42 W | E27



- A+** 1 x E-27 LED 12W
- A** 1 x E-27 vintage LED 8W
- B** 1 x E-27 vintage Edison 40W

FLORÓN EN NEGRO U ÓXIDO

BLACK OR OXIDE CEILING ROSE

PAVILLON EN NOIR OU EN OXYDE

PANTALLA METÁLICA EN NEGRO O EN ÓXIDO

BLACK OR OXIDE METALLIC LAMP SHADE

ABAT-JOUR MÉTALLIQUE EN NOIR OU EN OXYDE

Diámetro 35 cm

Diameter 35 cm

Diamètre 35 cm

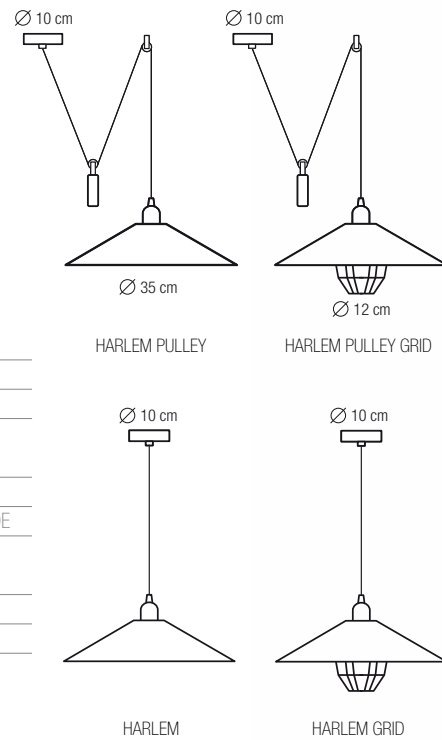

HARLEM	HARLEM GRID	HARLEM PULLEY	HARLEM PULLEY GRID	FLORÓN Y PANTALLA CEILING ROSE & LAMP SHADE PAVILLON ET ABAT-JOUR	CABLE CABLE CÂBLE
1194	1198	1202	1206	● Negro Black   Noir	Algodón negro Black cotton   Coton noir
1195	1199	1203	1207	● Negro Black   Noir	Trenzado negro Black braided   Torsadé noir
1196	1200	1204	1208	● Óxido Oxide   Oxyde	Algodón marrón Brown cotton   Coton marron
1197	1201	1205	1209	● Óxido Oxide   Oxyde	Trenzado marrón Brown braided   Torsadé marron





# BRONX C

IP20 CE

max. 42 W | E27

- A+ 1 x E-27 LED 12W
- A 1 x E-27 FLC 25W
- A+ 1 x E-27 vintage LED 8W
- B 1 x E-27 vintage Edison 40W

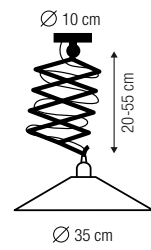

BRONX C

ESTRUCTURA EN NEGRO U ÓXIDO

BLACK OR OXIDE STRUCTURE

STRUCTURE EN NOIR OU EN OXYDE

PANTALLA METÁLICA EN NEGRO O EN ÓXIDO

BLACK OR OXIDE METALLIC LAMPSHADE

ABAT-JOUR MÉTALLIQUE EN NOIR OU EN OXYDE

Pantalla diámetro 35 cm. Rejilla diámetro 12 cm

Lampshade diameter 35 cm. Grid diameter 12 cm

Abat-jour diamètre 35 cm. Grille diamètre 12 cm

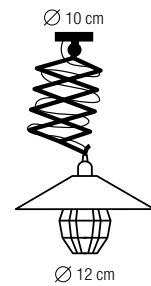

BRONX C GRID

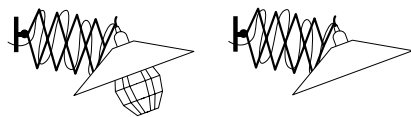
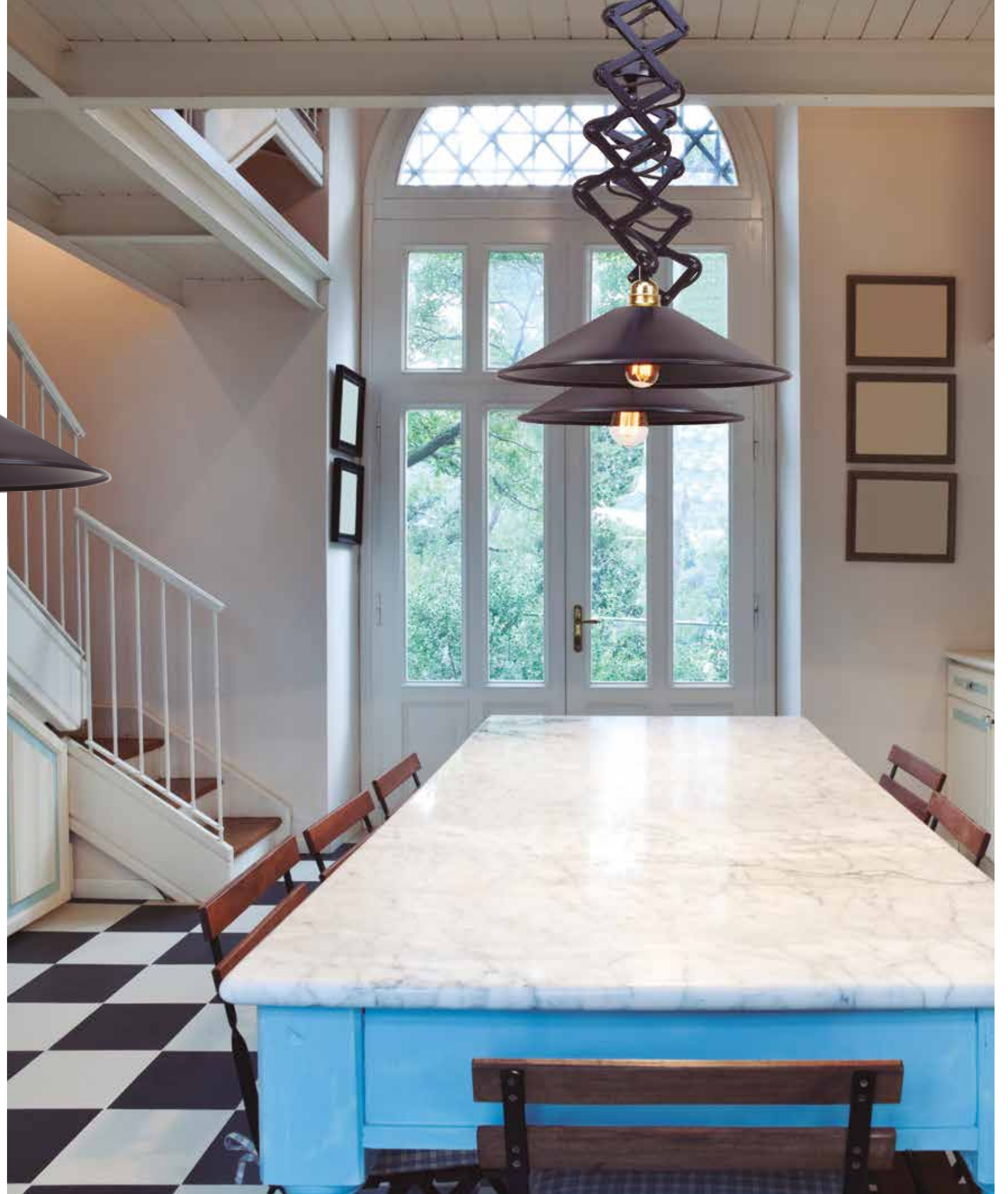

p. 186

BRONX	BRONX GRID	ESTRUCTURA STRUCTURE STRUCTURE	PANTALLA LAMP SHADE ABAT-JOUR	CABLE CÂBLE CÂBLE
1210	1212	● Negro Black   Noir	● Negro Black   Noir	Algodón negro Black cotton   Coton noir
1211	1213	● Óxido Oxide   Oxyde	● Óxido Oxide   Oxyde	Algodón marrón Brown cotton   Coton marron

# LONDON C

IP20 CE

max. 42 W | E27

- A+** 2 x E-27 LED 12W
- A** 2 x E-27 FLC 25W
- B** 2 x E-27 A60 ECO 42W

ESTRUCTURA EN ÓXIDO O NEGRO

OXIDE OR BLACK STRUCTURE

STRUCTURE EN OXYDE OU EN NOIR

PANTALLA DE LONETA, OSAKA, ARPILLERA,  
LINBA O METÁLICA

COTTON, OSAKA, SACKING, LINBA OR METALLIC  
LAMP SHADE

ABAT-JOUR EN COTON, EN OSAKA, EN TOILE, EN  
LINBA OU EN MÉTAL

Pantalla 30 x 20 x 15 cm. Pantalla metálica 35 cm

Lampshade 30 x 20 x 15 cm. Metallic lampshade  
35 cm

Abat-jour 30 x 20 x 15 cm. Abat-jour en métal 35 cm

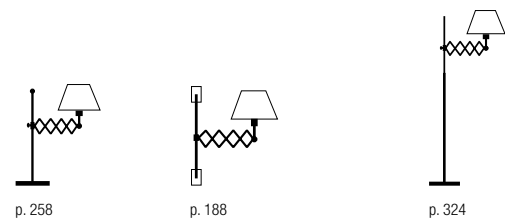
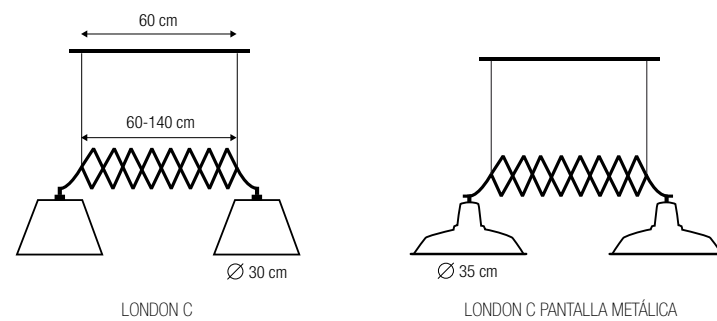

LONDON C	LONDON C PANTALLA METÁLICA LONDON C METALLIC LAMP SHADE LONDON C ABAT-JOUR EN MÉTAL	ESTRUCTURA STRUCTURE STRUCTURE	PANTALLA LAMP SHADE ABAT-JOUR	CABLE CABLE CÂBLE
1214	● Óxido <i>Oxide   Oxyde</i>	■ Loneta <i>Cotton   Coton</i>	Trenzado marrón <i>Brown braided   Torsadé marron</i>	
1215	● Óxido <i>Oxide   Oxyde</i>	■ Osaka	Trenzado marrón <i>Brown braided   Torsadé marron</i>	
1216	● Óxido <i>Oxide   Oxyde</i>	■ Arpillera beige <i>Beige sacking   Toile beige</i>	Trenzado marrón <i>Brown braided   Torsadé marron</i>	
1217	● Óxido <i>Oxide   Oxyde</i>	■ Saco <i>Sack   Jute</i>	Trenzado marrón <i>Brown braided   Torsadé marron</i>	
1218	● Óxido <i>Oxide   Oxyde</i>	■ Linba marrón <i>Brown linba   Linba marron</i>	Trenzado marrón <i>Brown braided   Torsadé marron</i>	
	1222	● Óxido <i>Oxide   Oxyde</i>	■ Óxido <i>Oxide   Oxyde</i>	Trenzado marrón <i>Brown braided   Torsadé marron</i>
1219	● Negro <i>Black   Noir</i>	■ Loneta <i>Cotton   Coton</i>	Trenzado negro <i>Black braided   Torsadé noir</i>	
1220	● Negro <i>Black   Noir</i>	■ Osaka	Trenzado negro <i>Black braided   Torsadé noir</i>	
1221	● Negro <i>Black   Noir</i>	■ Arpillera beige <i>Beige sacking   Toile beige</i>	Trenzado negro <i>Black braided   Torsadé noir</i>	
	1223	● Negro <i>Black   Noir</i>	■ Negro <i>Black   Noir</i>	Trenzado negro <i>Black braided   Torsadé noir</i>



# PROA C

IP20 CE

max. 42 W | E27



- A+** 1 x E-27 LED 12W
- A** 1 x E-27 vintage LED 8W
- B** 1 x E-27 vintage Edison 40W

FLORÓN EN NEGRO U ÓXIDO

BLACK OR OXIDE CEILING ROSE

PAVILLON EN NOIR OU EN OXYDE

PANTALLA METÁLICA EN NEGRO O EN ÓXIDO

BLACK OR OXIDE METALLIC LAMPSHADE

ABAT-JOUR MÉTALLIQUE EN NOIR OU EN OXYDE

Diámetro 18 cm

Diameter 18 cm

Diamètre 18 cm

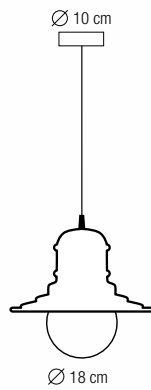

Lámparas colgantes / hanging lamps / suspensions

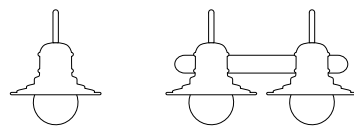



p. 198

	FLORÓN CEILING ROSE PAVILLON	PANTALLA LAMPSHADE ABAT-JOUR	CABLE CABLE CÂBLE
1224	● Negro Black   Noir	■ Negro Black   Noir	Algodón negro Black cotton   Coton noir
1225	● Óxido Oxide   Oxyde	■ Óxido Oxide   Oxyde	Algodón marrón Brown cotton   Coton marron

# BROOKLIN

IP20 CE

max. 42 W | E27

-  **A+** 1 x E-27 LED 12W
-  **A** 1 x E-27 FLC 25W
-  **B** 1 x E-27 A60 ECO 42W

FLORÓN EN NEGRO O BLANCO

BLACK OR WHITE CEILING ROSE

PAVILLON EN NOIR OU EN BLANC

PANTALLA METÁLICA EN NEGRO O EN BLANCO

BLACK OR WHITE METALLIC LAMPSHADE

ABAT-JOUR MÉTALLIQUE EN NOIR OU EN BLANC

Diámetro 20 cm

Diameter 20 cm

Diamètre 20 cm

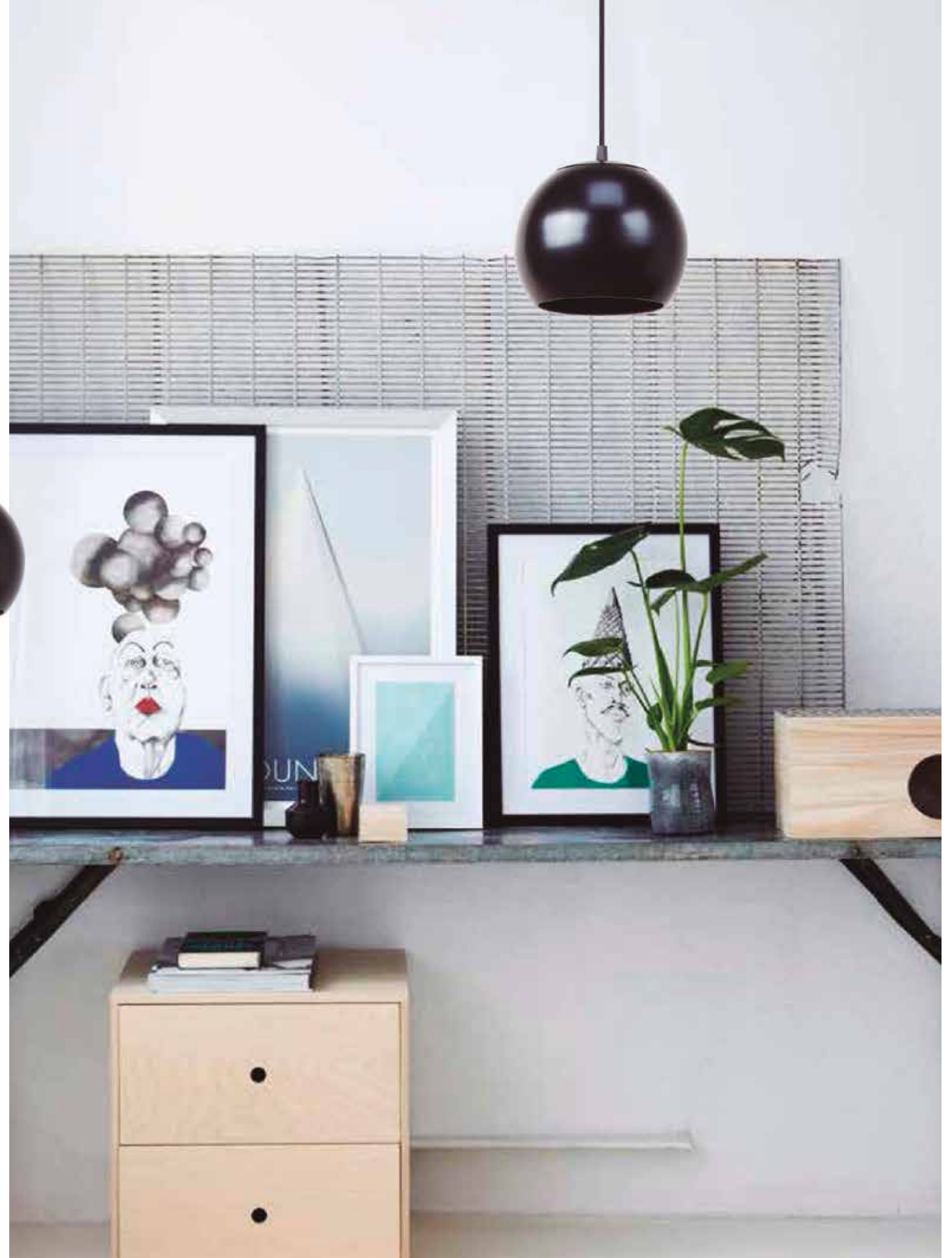
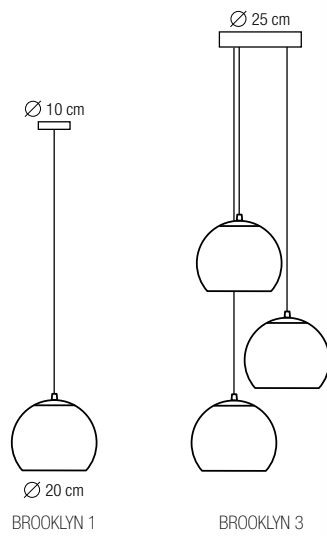

BROOKLIN 1	BROOKLIN 3	ESTRUCTURA STRUCTURE STRUCTURE	CABLE CABLE CÂBLE
1226	1228	● Negro Black   Noir	Algodón negro Black cotton   Coton noir
1227	1229	● Blanco White   Blanc	Algodón negro Black cotton   Coton noir

# CHELSEA

IP20 CE

max. 42 W | E27

- A** 1 x E-27 vintage LED 8W
- B** 1 x E-27 vintage Edison 40W

FLORÓN EN BLANCO, ÓXIDO O NEGRO

WHITE, OXIDE OR BLACK CEILING ROSE

PAVILLON EN BLANC, EN OXYDE OU EN NOIR

Portalámparas de latón

Brass lampholder

Douille de laiton

REJILLA EN ÓXIDO O NEGRO

OXIDE OR BLACK GRID

GRILLE EN OXYDE OU EN NOIR

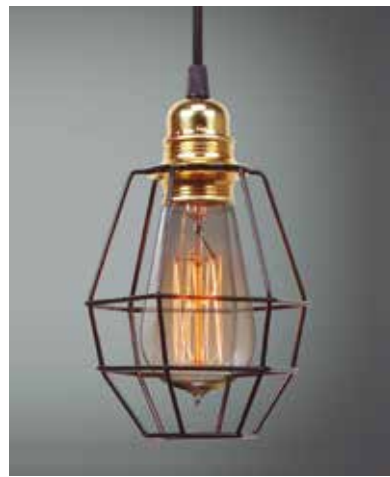
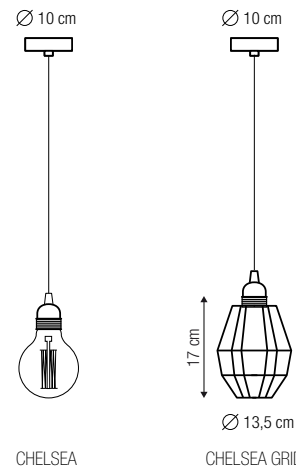

CHELSEA	CHELSEA GRID	FLORÓN CEILING ROSE PAVILLON	REJILLA GRID GRILLE	CABLE CABLE CÂBLE
1230		● Negro Black   Noir	-	Algodón negro Black cotton   Coton noir
1231		● Negro Black   Noir	-	Trenzado negro Black braided   Torsadé noir
1232		● Óxido Oxide   Oxyde	-	Algodón marrón Brown cotton   Coton marron
1233		● Óxido Oxide   Oxyde	-	Trenzado marrón Brown braided   Torsadé marron
1234		● Blanco White   Blanc	-	Algodón blanco White cotton   Coton blanc
	1235	● Negro Black   Noir	■ Negro Black   Noir	Algodón negro Black cotton   Coton noir
	1236	● Negro Black   Noir	■ Negro Black   Noir	Trenzado negro Black braided   Torsadé noir
	1237	● Óxido Oxide   Oxyde	■ Óxido Oxide   Oxyde	Algodón marrón Brown cotton   Coton marron
	1238	● Óxido Oxide   Oxyde	■ Óxido Oxide   Oxyde	Trenzado marrón Brown braided   Torsadé marron

