

# luxcambra

SINCE 1966

## Astoria

LUXCAMBRA TEAM

Lámpara de suspensión *Hanging lamp* Suspension



### Descripción *Description* Description

- > La lámpara de suspensión Astoria se inspira en el diseño industrial y se presenta en dos formas con pantallas metálicas que quedan suspendidas de forma elegante creando ambientes cálidos a su alrededor. Especialmente adecuada en proyectos de restauración, cocinas o espacios de trabajo ya sea de forma individual o seriada.
- > *The Astoria pendant lamp is inspired by industrial design and comes in two shapes with metal shades that are elegantly suspended to create a warm atmosphere around them. Particularly suitable for use in catering projects, kitchens or workspaces, either individually or in series.*
- > La lampe suspendue Astoria s'inspire du design industriel et se décline en deux formes avec des abat-jours en métal qui sont élégamment suspendus pour créer une atmosphère chaleureuse autour d'eux. Particulièrement adaptée aux projets de restauration, aux cuisines ou aux espaces de travail, elle peut être utilisée individuellement ou en série.

### Materiales y acabados *Materials and finishes* Matériaux et finitions

- > Florón y pantalla metálica monocolor en blanco, negro, óxido o color RAL
- > *Single-colour metal rosette and shade in white, black, rust or RAL colour*
- > Rosace et abat-jour métalliques unicolores en blanc, noir, rouille ou couleur RAL

### Cable *Cable* Câble

- > Cable de PVC negro
- > *Black PVC cable*
- > Câble en PVC noir

### Características eléctricas *Electrical characteristics* Caractéristiques électriques

Bombilla E-27 LED 12W o E-27 vintage LED  
Máx. 42W



### Medidas generales *General Measures* Mesures générales

Astoria Small  
Pantalla diámetro 31,5 cm y altura 27 cm

Astoria Large  
Pantalla diámetro 47,5 cm y altura 26 cm

### Embalaje *Packaging* Emballage

- > 1 caja
- > *1 box*
- > 1 carton



34 x 34 x 30 / 0.03 m3  
13.4" 13.4" 11.8" / 1.06 ft3



### Peso *Weight* Poids

3.5 kg  
7.7 lb

### Mantenimiento *Maintenance* Entretien







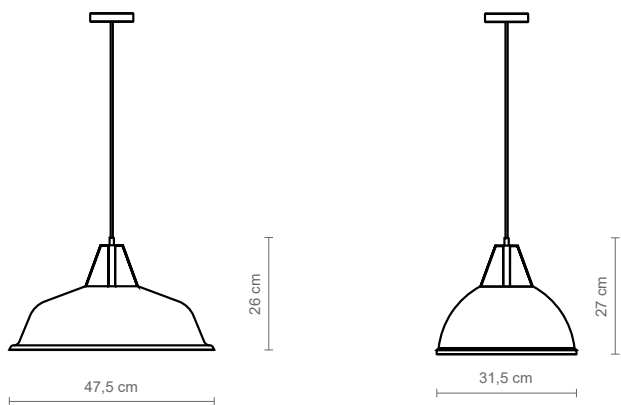

- > Limpiar con tela suave ligeramente humedecida con agua. No utilizar detergentes, amoníaco o productos abrasivos.
- > *Wipe with a clean soft cloth slightly dampened with water. Do not use ammonia, solvents or abrasive cleaning products.*
- > Nettoyage avec un tissu doux légèrement humidifié avec de l'eau. Ne pas utiliser d'ammoniaque, solvants ou autres substances abrasives d'entretien.

### Uso *Use* Usage

- > Interior
- > *Indoor*
- > Intérieur



Referencias *References* Reference

SMALL	CEILING ROSE PAVILLON	LAMP SHADE ABAT-JOUR	CABLE CÂBLE
1316	 Negro Black   Noir	 Negro Black   Noir	PVC negro Black PVC   PVC noir
1317	 Óxido Oxide   Oxyde	 Óxido Oxide   Oxyde	PVC negro Black PVC   PVC noir
1318	 Blanco White   Blanc	 Blanco White   Blanc	PVC negro Black PVC   PVC noir
1319	 Color RAL RAL color   Couleur RAL	 Color RAL RAL color   Couleur RAL	PVC negro Black PVC   PVC noir